

Voltech

VOLTECH INSTRUMENTS

AT5600 Wound Component Tester



User Manual

Voltech AT5600 Wound Component Tester

AT5600 User Manual

Thank you for choosing the Voltech AT5600.

This wound component tester should give you many years of reliable use.

Should you experience any difficulty during the set up or use of your Voltech product, please do not hesitate to contact either your local supplier or one of our main offices.

sales@voltech.com
www.voltech.com

© Voltech Instruments All rights reserved.

No part of this publication may be produced, stored in a retrieval system, or transmitted in any form, or by means, electronic, mechanical photocopying, recording or otherwise without prior written permission of Voltech.

Issue 26 / 28 Aug 2023

Table of Contents

1. Introduction	9
1.1. AT5600 New Features.....	9
1.2. How to use this manual	10
1.2.1. How to Use this Manual – English.....	10
1.2.2. Mode d'utilisation de ce manuel – Français	10
1.2.3. Verwendung dieses Handbuchs – Deutsch	11
1.2.4. Cómo Usar Este Manual – Español	11
1.2.5. Come usare questo manuale – Italiano	12
1.2.6. Zo gebruikt u deze handleiding – Nederlands.....	12
1.2.7. Sådan bruger du denne manual – Dansk	13
1.2.8. Så här använder du bruksanvisningen -Svenska.....	13
1.2.9. Taman oppaan kayttoohjeet – Suomi	14
1.2.10. Pouziti teto prirucky – Cestina	14
1.2.11. Hogy kell használni ezt a kézikönyvet – Magyar	15
1.2.12. Jak korzystać z niniejszej instrukcji – Polski.....	15
1.2.13. Kılavuzun Kullanımı - Türkçe.....	16
1.3. General Safety Instructions	17
1.3.1. General safety Instructions - English.....	17
1.3.2. Consignes générales de sécurité – Français	18
1.3.3. Allgemeine Sicherheitshinweise – Deutsch	19
1.3.4. Instrucciones Generales de Seguridad – Español	20
1.3.5. Istruzioni generali di sicurezza – Italiano	21
1.3.6. Algemene veiligheidsinstructies – Nederlands.....	22
1.3.7. Generel sikkerhedsvejledning – Dansk.....	23
1.3.8. Allmänna säkerhetsanvisningar – Svenska	24
1.3.9. Yleiset turvallisuusohjeet – Suomi.....	25
1.3.10. Obecné bezpečnostní pokyny – Čeština	26
1.3.11. Általános biztonsági utasítások – Magyar	27
1.3.12. Ogólne instrukcje bezpieczeństwa – Polski.....	28
1.3.13. Genel Güvenlik Talimatları - Türkçe	29
1.4. Package Contents	30
2. System Overview.....	31
2.1. What is the AT5600?	31
2.2. What is the AT5600 used for?	32
2.3. AT5600 Features Summary	32
2.4. Front Panel Description	33
2.5. Rear Panel Description.....	35
2.6. Air Circulation	38
2.7. Tilt Feet.....	39
2.8. Lifting Points	39
2.9. A Typical Installation.....	40
2.9.1. Server PC – results and test program management.....	40
2.9.2. Editor PC – test program development	40
2.9.3. Test Fixture.....	41
2.9.4. Light Curtain (or another safety device)	41
3. Using the AT5600	43

3.1.	Usage Overview	43
3.2.	Test Fixtures	44
3.3.	Creating Test Programs - AT Editor	45
3.4.	Utilizing Editor Test Programs	47
3.4.1.	Storing programs on the Server	47
3.5.	Results Printing.....	49
3.5.1.	Report Format	49
3.6.	Recommended Configuration.....	51
3.7.	Operating the AT5600 in Production Test.....	52
3.7.1.	Manual Use	52
3.7.2.	Robotic Operation	52
4.	AT5600 Functional Description.....	53
4.1.	Behind the Front Panel.....	53
4.1.1.	Test Nodes	53
4.1.2.	Relay Switching Matrix	54
4.1.3.	Processors.....	54
4.1.4.	Test Sources	54
4.1.5.	Measurement Circuits	55
4.1.6.	Touch Screen & Buttons	56
4.1.7.	Interfaces.....	56
4.2.	How Does the AT5600 Tester Run a Test?	57
5.	Getting Started	59
5.1.	Installing the AT5600.....	59
5.2.	Installing the Windows Software.....	60
5.3.	Install the Server Software	60
5.4.	Quick Start Tutorial.....	61
5.4.1.	Creating a Simple Schematic.....	61
5.4.2.	Creating the Test Program	63
5.4.3.	Running the Program from the Editor	69
5.4.4.	Transferring the Program to the Server	71
5.5.	USB Printer Setup	75
5.6.	BARCODE Reader Setup.....	79
6.	Safety Systems.....	81
6.1.	Introduction	81
6.2.	Recommended Safety Systems	82
6.2.1.	Description of the Banner Light Curtain system.....	82
6.2.2.	Constructing your own Safety System	83
6.3.	Safety Notices.....	84
6.4.	A Typical Installation of a Safety System	84
6.5.	The AT5600 safety system user interface	86
6.6.	Constructing Safe Fixtures	87
6.7.	DC1000 DC Bias Current Source.....	87
6.8.	AC Interface Fixture.....	87
7.	Tests and Test Conditions.....	89
7.1.	Available Tests	89
7.1.1.	Low Voltage Tests	90
7.1.2.	High Voltage Tests	92
7.1.3.	DC1000 + DC1000A Tests.....	93
7.1.4.	AC Interface Tests.....	93
7.1.5.	Other Functionality Options.....	94
7.2.	Self-Resonant Frequency.....	95
7.3.	Explanation of Integration.....	96
7.4.	CTY - Continuity	98
7.5.	R - Winding Resistance	99
7.6.	RLS or RLP - Equivalent Series or Parallel Resistance	101

7.7.	LS or LP - Inductance (Series or Parallel Circuit).....	102
7.8.	LSB or LPB-Inductance with Bias Current (Series or Parallel Circuit)	105
7.9.	QL - Quality Factor	106
7.10.	D – Dissipation Factor.....	107
7.11.	LL - Leakage Inductance	108
7.12.	C - Interwinding Capacitance.....	110
7.13.	TR - Turns Ratio.....	113
7.13.1.	Best Practice for Centre Taps / Auto transformers.....	115
7.14.	TRL - Turns Ratio by Inductance	118
7.15.	Z, ZB – Impedance, Impedance with Bias	121
7.16.	R2 – DC Resistance Match.....	122
7.17.	L2 – Inductance Match.....	123
7.18.	C2 – Capacitance Match.....	126
7.19.	GBAL – General Longitudinal Balance	128
7.20.	LBAL – Longitudinal Balance.....	131
7.21.	ILOS – Insertion Loss	133
7.21.1.	Fixturing and Programming tip for using Source Resistors	134
7.22.	RESP – Frequency Response.....	136
7.23.	RLOS – Return Loss.....	138
7.24.	ANGL – Impedance Phase Angle.....	140
7.25.	PHAS – Interwinding Phase.....	142
7.26.	OUT – Output to User Port	144
7.27.	IR - Insulation Resistance	145
7.28.	HPDC - DC HI-POT (EHT).....	148
7.29.	HPAC - AC HI-POT (EHT).....	150
7.30.	SURG - Surge Stress.....	152
7.31.	WATT - Wattage	155
7.32.	WATX - Wattage (External Source).....	156
7.33.	STRW – Stress Watts	158
7.34.	STRX – Stress Watts (External Source).....	159
7.35.	MAGI - Magnetizing Current	161
7.36.	MAGX - Magnetizing Current (External Source).....	163
7.37.	VOC - Open Circuit Voltage	165
7.38.	VOCX - O/C Voltage (External Source).....	167
7.39.	LVOC – Low Voltage Open Circuit	170
7.40.	ILK – Leakage Current.....	172
7.41.	LSBX – Inductance with External Bias (Series Circuit).....	173
7.42.	LPBX – Inductance with External Bias (Parallel Circuit).....	174
7.43.	ZBX - Impedance with External Bias	175
7.44.	ACRT - AC HI-POT Ramp	176
7.45.	DCRT - DC HI-POT Ramp	177
7.46.	ACVB - AC Voltage Break Down	178
7.47.	DCVB - DC Voltage Break Down.....	179
7.48.	WAIT – Fixed duration or Indefinite Test Delay	180
7.49.	PWRF – Power Factor Test.....	182

8. Front Panel Operation..... 185

8.1.	Introduction	185
8.1.1.	The Touch Screen Display	185
8.1.2.	RUN and STOP buttons	186
8.1.3.	User Input.....	186
8.1.4.	Splash Screen	187
8.1.5.	Power On.....	187
8.1.6.	PART LIST	188
8.1.6.1	Entering a Part Number	189
8.1.6.2	Serial Number	191
8.1.6.3	Batch	192
8.1.6.4	Operator	193
8.1.6.5	Compensation	194
8.1.6.6	Run Screen	200

8.1.6.7 Results	202
8.1.6.8 Schematic.....	203
8.1.7. Self-Test	206
8.1.8. Set-Up	208
8.1.9. Sound	209
8.1.10. Clock	210
8.1.11. Server	211
8.1.12. Network.....	212
8.1.13. Compatibility	213
8.1.13.1 AT3600 Compatibility Mode	213
8.1.13.2 Language	215
8.1.14. Unit Information.....	216
8.1.15. Status Bar Icons.....	217
8.2. Testing Wound Components	219
8.2.1. A Typical Workflow	219
8.2.2. Traceability	221
8.2.3. STOP ON FAIL function	222
8.2.4. Getting the Results	223
9. Troubleshooting	225
9.1. Measurement Error Codes	225
9.1.1. Test error codes	225
9.1.2. Editor Error Codes.....	226
9.1.3. Status Code Example.....	226
9.1.4. Common error codes.....	228
9.2. Correcting Errors	229
9.2.1. Safety Interlock error	229
9.2.2. Temperature error	229
9.2.3. Voltage Present Error	230
10. Specifications	231
10.1. Specification Summary	231
10.1.1. Low Voltage Tests	232
10.1.2. High Voltage Tests	233
10.1.3. DC1000 + DC1000A Tests	233
10.1.4. AC Interface Tests	233
10.2. Accuracy Specifications – Available Tests	235
10.2.1. R Test	235
10.2.2. LS, LP, RLS, RLP, LL and C Tests.....	236
10.2.3. QL and D Tests.....	237
10.2.4. TR Test	238
10.2.5. TRL Test	239
10.2.6. MAGI Test.....	240
10.2.7. MAGX Test (External Source)	241
10.2.8. VOC Test	242
10.2.9. VOCX Test (External Source).....	243
10.2.10. LVOC Test	244
10.2.11. IR Test	245
10.2.12. HPDC Test.....	246
10.2.13. HPAC Test.....	247
10.2.14. LSB AND LPB Tests	248
10.2.15. WATT and STRW Tests	249
10.2.16. WATX and STRX Tests (External Source).....	250
10.2.17. SURG Test.....	251
10.2.17.1 Max programmable SURG voltage	252
10.2.18. L2, C2 and R2 Tests	253
10.2.19. GBAL Test	254
10.2.20. LBAL and ILOS Tests	255
10.2.21. RESP Test	256

10.2.22.	RLOS Test	257
10.2.23.	Z and ZB Test	258
10.2.24.	ANGL Test	259
10.2.25.	PHAS Test	260
10.2.26.	ILK Test.....	261
10.2.27.	LSBX and LPBX Tests.....	262
10.2.28.	ZBX Test.....	263
10.2.29.	ACRT Test	264
10.2.30.	DCRT Test.....	265
10.2.31.	ACVB Test	266
10.2.32.	DCVB Test.....	267
10.2.33.	PWRF Test	268
10.3.	Interface Specifications	269
10.3.1.	Server Port.....	269
10.3.2.	Auxiliary Port.....	270
10.3.3.	Remote Port.....	271
10.3.4.	Peripheral Interface	274
10.3.5.	Safety Interlock	275
10.3.6.	User Port.....	276
10.3.7.	Ethernet Port.....	278
10.3.8.	Front and Rear USB 'A' Ports.....	278
10.3.9.	USB 'B' Port.....	278
10.4.	Environmental Conditions	279
10.5.	Mechanical	280
10.6.	EMC Compliance	281
10.6.1.	Declaration of Conformity	281
11.	Maintenance.....	282
11.1.	Air Filters	282
11.1.1.	Removing the right-hand side panel.....	282
11.1.2.	Removing the air filters	283
11.2.	Test Probes.....	283
11.3.	Power Cords	283
11.4.	Cleaning	283
12.	Warranty and Service.....	284
12.1.	Warranty Information	284
12.1.1.	Post-sale Warranty Agreement.....	284
12.2.	Service and Calibration.....	285
12.3.	Accessories.....	286
13.	Test Fixtures	288
13.1.	Introduction	288
13.2.	The Voltech Fixture System.....	289
13.2.1.	Description of the Fixture System.....	289
13.2.2.	Compatible connection types.....	290
13.3.	The Voltech 40 Socket Fixture.....	290
13.4.	Making Fixture Connections – Kelvin Connections	291
13.5.	Compensation	293
13.5.1.	Compensation Summary – Available Tests.....	294
13.5.2.	Equipment Required	295
13.6.	General Notes	297
13.6.1.	Beware of High Voltages	297
13.6.2.	Kelvin Connections	298
13.6.3.	Mechanical Problems	298
13.6.4.	Cleaning Test Pins.....	298
14.	AT Series Editor Software	300
14.1.	Firmware Upgrades	301

14.2.	Self-Test.....	303
14.3.	Customize Tester.....	305
15.	AT Series Server Software	306
16.	Manual, Firmware, Software - Change Log	307
16.1.	AT5600 User Manual	308
16.2.	AT5600 Firmware.....	310

1. Introduction

An introduction to the AT5600 Wound Component Tester

This user manual details the operation of the Voltech AT5600 Wound Component Tester. Please study this introductory chapter carefully as it will help to setup the product quickly and safely. It will also help to get the most from the product by introducing all its features and capabilities.

1.1. AT5600 New Features

The AT5600 is the next generation of AT Wound Component Testers offered by Voltech. New features include:

- 2 x faster testing increases productivity.
- Ethernet Port
 - For networked server communications
 - Wireless capability
- USB Ports
 - For simple program editing and printing
- Measurements optimized for speed with accuracy.
- Fast stabilization of magnetizing current
- Audit Testing (run specified tests every X part, where X=2 to 99)
- Diagnostic Testing (run specified tests only if any main + audit test fail)
- Load Compensation

1.2. How to use this manual

1.2.1. How to Use this Manual – English

The following icon key shows the convention used throughout this manual to help identify key points that should be read and understood.



Important safety information. All safety information must be read and understood.



Important information that explains a general principal that should be understood in order to use the product effectively.

If any information is not clear, then please visit the Voltech website for more information or contact us for assistance.

1.2.2. Mode d'utilisation de ce manuel – Français

L'icône suivante indique la convention utilisée dans l'ensemble de ce manuel afin d'identifier les points clés qui doivent être lus et assimilés.



Informations importantes relatives à la sécurité.
Toutes les informations relatives à la sécurité doivent être lues et assimilées.



Les informations importantes donnent l'explication d'un principe général qui doit être assimilé afin d'utiliser le produit efficacement.

Si des informations ne sont pas claires, veuillez consulter le site Web de Voltech pour obtenir un complément d'information ou nous contacter pour obtenir de l'aide.

1.2.3. Verwendung dieses Handbuchs – Deutsch

Die folgende Symbollegende zeigt die in diesem Handbuch verwendeten Konventionen zur Hervorhebung wichtiger Punkte, die gelesen und verstanden werden müssen.



Wichtige Sicherheitshinweise.
Alle Sicherheitshinweise müssen gelesen und verstanden werden.



Wichtige Informationen, die ein allgemeines Prinzip erklären, das verstanden werden muss, damit das Produkt effektiv genutzt werden kann.

Falls Informationen nicht klar sind, besuchen Sie bitte die Voltech-Website, um dort weitere Informationen zu erhalten, oder kontaktieren Sie uns, damit wir Ihnen weiterhelfen können.

1.2.4. Cómo Usar Este Manual – Español

Las siguientes claves de iconos muestran los avisos convenidos para usarlos en este manual, para poder identificar aspectos importantes que deben ser leídos y comprendidos.



Información importante de seguridad.
Toda la información de seguridad tiene que ser leída y comprendida.



Información importante que explica un principio general que debe ser comprendido para usar el producto con eficacia.

Si alguna información no aparece clara le rogamos visitar el sitio web de Voltech para mayor detalle o contactarnos para solicitar ayuda.

1.2.5. Come usare questo manuale – Italiano

La seguente legenda mostra le icone convenzionali usate in questo manuale per segnalare i punti chiave che richiedono un'attenta lettura e comprensione.



Informazioni importanti per la sicurezza.
Tutte le informazioni riguardanti la sicurezza devono essere lette e comprese.



Informazioni importanti che spiegano un principio generale da comprendere per utilizzare efficacemente il prodotto.

In caso di dubbi in merito a qualunque informazione contenuta nel manuale, visitare il sito web Voltech per chiarimenti o contattare gli uffici Voltech per richiedere assistenza.

1.2.6. Zo gebruikt u deze handleiding – Nederlands

De volgende pictogramtoets toont de conventie die in deze handleiding wordt gebruikt als hulpmiddel bij het identificeren van de belangrijkste punten die gelezen en begrepen moeten worden.



Belangrijke veiligheidsinformatie.
Alle veiligheidsinformatie moet gelezen en begrepen worden.



Belangrijke informatie die een algemeen principe verklaart dat men dient te begrijpen om het product effectief te gebruiken.

Ga naar de Voltech-website voor meer informatie als iets in de informatie niet duidelijk is, of neem contact met ons op voor hulp.

1.2.7. Sådan bruger du denne manual – Dansk

Det følgende ikon viser den konvention, der bruges i denne manual til at hjælpe med at identificere de vigtigste punkter, der skal læses og forstås.



Vigtige sikkerhedsoplysninger.
Alle sikkerhedsoplysninger skal læses og forstås.



Vigtige oplysninger, der forklarer et generelt princip, der skal forstås for at kunne bruge produktet effektivt.

Hvis noget er uklart, skal du besøge Voltechs websted for at få flere oplysninger eller kontakte os for at få hjælp.

1.2.8. Så här använder du bruksanvisningen - Svenska

Följande ikoner visar hur viktiga punkter som ska läsas och förstås har markerats i den här bruksanvisningen.



Viktig säkerhetsinformation.
All säkerhetsinformation måste läsas och förstås.



Viktig information som förklarar en allmän princip som måste förstås för effektiv användning av produkten.

Om någon information är oklar kan du besöka Voltechs webbplats för mer information eller kontakta oss för att få hjälp.

1.2.9. **Taman oppaan kayttoohjeet – Suomi**

Seuraavassa kuvakkeiden selityksessä näkyy tässä oppaassa käytössä oleva käytäntö, jolla on merkitty keskeiset seikat, jotka on luettava ja sisäistettävä.



Tärkeitä turvallisuustietoja
Kaikki turvallisuustiedot on luettava ja sisäistettävä.



Tärkeitä tietoja, jotka selittävät yleisperiaatteen, joka on sisäistettävä, jotta tätä tuotetta voidaan käyttää tehokkaasti.

Jos jotkin tiedot eivät ole selkeitä, saat lisätietoja Voltechin verkkosivustolta tai voit pyytää meiltä neuvoa.

1.2.10. **Pouziti teto prirucky – Cestina**

Následující symboly jsou používány v celé příručce a usnadňují identifikaci klíčových bodů, které je nutné prostudovat a pochopit.



Důležité bezpečnostní informace.
Všechny bezpečnostní informace je nutné prostudovat a pochopit.



Důležité informace vysvětlující obecné principy, kterým je v zájmu efektivního použití produktu nutné porozumět.

Pokud některé informace nejsou srozumitelné, navštivte web společnosti Voltech, kde naleznete další informace a můžete si vyžádat naši pomoc.

1.2.11. Hogy kell használni ezt a kézikönyvet – Magyar

Az alábbi ikon jelmagyarázat ismerteti az e kézikönyvben végig alkalmazott egyezményes jelölést azon fő pontok azonosítására, amelyek elolvasása és megértése nélkülözhetetlen.



Fontos biztonsági információ.
Minden biztonsági információ elolvasása és megértése kötelező.



Fontos információ egy olyan általános elv ismertetésére, amelyet érteni kell a termék hatékony alkalmazása érdekében.

Ha bármely információ nem világos, kérjük, látogasson el a Voltech weboldalára további tájékoztatásért vagy forduljon hozzánk segítségért.

1.2.12. Jak korzystać z niniejszej instrukcji – Polski

Poniższa legenda z opisem znaczenia ikon przedstawia konwencję stosowaną w niniejszej instrukcji w celu ułatwienia określenia kluczowych informacji do przeczytania i zrozumienia.



Ważne informacje o bezpieczeństwie.
Wszystkie informacje dotyczące bezpieczeństwa należy przeczytać i zrozumieć.



Ważne informacje wyjaśniające ogólną zasadę, którą należy zrozumieć w celu właściwego użytkowania produktu.

Jeśli podane informacje są niejasne, wówczas należy uzyskać dodatkowe informacje ze strony internetowej firmy Voltech lub skontaktować się z nami z prośbą o pomoc.

1.2.13. Kılavuzun Kullanımı - Türkçe

Bu kullanım kılavuzunun tümünde kullanılmış aşağıdaki simgeler (ikon), mutlaka okunup anlaşılması gereken temel hususları göstermektedir.



Önemli güvenlik bilgisi.
Bu türden bütün güvenlik bilgileri mutlaka okunmalı ve anlaşılmalıdır.



Ürünün verimli bir şekilde kullanılması için anlaşılması gereken genel ilkeleri açıklayan önemli bilgiler.

Tam olarak anlayamadığınız şeyleri lütfen Voltech sitesinde ayrıntılı olarak inceleyiniz ya da yardım almak için bizimle temas kurunuz.

1.3. General Safety Instructions

1.3.1. General safety Instructions - English

Electrical devices can constitute a safety hazard. It is the responsibility of the user to ensure the compliance of the installation with any local acts or bylaws in force. Only qualified personnel should install this equipment after reading and understanding this user manual. These operating instructions should be adhered to. If in any doubt, please contact your supplier.



DANGER! ELECTRIC SHOCK RISK



WARNING: The AT5600 must be connected to a safety ground (earth). Only insert the power lead into a socket with a protective ground contact. Ensure that the power lead is in good condition and free from damage before use.



Replace the fuses only with the same type and rating: 2.0AT 5X20 ANTISURGE.

Refer servicing only to qualified personnel who understand the danger of shock hazards.



WARNING: The AT5600 can generate voltages that may be LETHAL. The safety interlock is designed to ensure the safety of operators when used with a Voltech approved safety system. To ensure operator safety, this interlock must always be properly connected to a Voltech approved safety system.

This product has been constructed in compliance with the requirements of EN61010-1, Pollution Degree 2, and Installation Category II: FOR INDOOR USE ONLY. This ensures the safety of the instrument and the user when normal precautions are followed.

1.3.2. Consignes générales de sécurité – Français

Les appareils électriques peuvent constituer un danger pour la sécurité. Il incombe à l'utilisateur de s'assurer de la conformité de l'installation avec les lois locales ou les arrêtés municipaux en vigueur. Seul le personnel qualifié doit installer cet équipement, après avoir lu et assimilé le manuel de l'utilisateur. Ces consignes d'utilisation doivent être suivies. En cas de doute, veuillez contacter votre fournisseur



DANGER ! Risque d'électrocution



ATTENTION : L'AT5600 doit être connecté à une prise de terre de sécurité. Ne brancher le cordon d'alimentation que sur une prise ayant un contact de protection avec la terre. S'assurer que le cordon d'alimentation est en bon état et exempt de dommage avant utilisation. Ne remplacer les fusibles que par des fusibles de mêmes type et calibre : 2.0AT 5X20 TEMPORISÉ. Ne confier la révision et la réparation de l'appareil qu'à du personnel qualifié qui a une connaissance des risques d'électrocution.



ATTENTION : L'AT5600 peut générer des tensions susceptibles d'être MORTELLES. Le verrouillage réciproque de sécurité est conçu pour assurer la sécurité des opérateurs lors de son utilisation avec un système de sécurité agréé par Voltech. Afin d'assurer la sécurité de l'opérateur, ce verrouillage réciproque doit être toujours connecté à un système de sécurité agréé par Voltech. **Pour toutes précisions, veuillez consulter le chapitre 6 de ce manuel de l'utilisateur.**

La construction du DC1000A est conforme aux exigences de la norme EN61010-1, Degré de pollution 2, Catégorie d'installation II: POUR UNE UTILISATION INTÉRIEURE UNIQUEMENT. La sûreté de l'instrument et la sécurité de l'utilisateur sont ainsi assurées lorsque les précautions habituelles sont prises.

1.3.3. Allgemeine Sicherheitshinweise – Deutsch

Elektrogeräte können ein Sicherheitsrisiko darstellen.

Es obliegt dem Benutzer, dafür zu sorgen, dass das Gerät nach den aktuellen Gesetzen und Vorschriften installiert wird.

Dieses Gerät darf nur von qualifiziertem Personal installiert werden, das dieses Benutzerhandbuch gelesen und verstanden hat.

Die Anweisungen in diesem Benutzerhandbuch müssen befolgt werden. Im Zweifelsfall wenden Sie sich bitte an Ihren Lieferanten.



GEFAHR! Stromschlaggefahr



WARNUNG: Die AT5600 muss geerdet werden.

Das stromführende Kabel nur an einer Steckdose mit einem Schutzerdekontakt anschließen. Vor Gebrauch prüfen, ob das stromführende Kabel in gutem Zustand und unbeschädigt ist. Die trägen Feinsicherungen nur durch träge Feinsicherungen desselben Typs und mit demselben Nennwert ersetzen: 5 x 20 mm, 2,0 A. Wartungsarbeiten dürfen nur von qualifiziertem Personal durchgeführt werden, das die Gefahr von Stromschlägen versteht.



WARNUNG: Die AT5600 kann Spannungen erzeugen, die TÖDLICH sein können.

Der Sicherheitsinterlock ist zum Schutz von Bedienern beim Einsatz mit einem von Voltech zugelassenen Sicherheitssystem vorgesehen. Um den Schutz von Bedienern zu gewährleisten, muss dieses Interlock immer ordnungsgemäß an einem von Voltech zugelassenen Sicherheitssystem angeschlossen sein.

Zu vollständigen Details siehe Kapitel 6 dieses Benutzerhandbuchs.

Dieses Produkt erfüllt die Anforderungen von DIN EN 61010-1 Verschmutzungsgrad 2 und Installationskategorie II: NUR FÜR INNENEINSATZ. Hierdurch wird die Sicherheit des Instruments und des Benutzers gewährleistet, solange normale Sicherheitsvorkehrungen befolgt werden.

1.3.4. Instrucciones Generales de Seguridad – Español

Los dispositivos eléctricos pueden constituir un riesgo de seguridad. Es la responsabilidad del usuario asegurar el cumplimiento de la instalación con todas las leyes y reglamentos locales vigentes. Este equipo debe ser instalado solo por personal calificado después de leer y comprender este manual del usuario. Estas instrucciones de operación deben ser cumplidas. Ante cualquier duda, le rogamos ponerse en contacto con su proveedor.



¡PELIGRO! Riesgo de Choque Eléctrico



ADVERTENCIA: El AT5600 tiene que ser conectado a una toma de tierra segura. Inserte el cable tomacorriente solo a una toma provista de un contacto protector de tierra. Asegúrese que el cable tomacorriente está en buenas condiciones y sin daños antes de usarlo. Recambie los fusibles solo con el mismo tipo y potencia nominal: 2.0AT 5X20 CON PROTECCIÓN DE SOBRECARGAS. El servicio o reparación tiene que ser encargado solo a personal calificado que comprende el peligro de los riesgos de electrocución.



ADVERTENCIA: El AT5600 puede generar voltajes LETALES. El enclavamiento de seguridad está diseñado para asegurar la seguridad de los operarios cuando se usa con un sistema de seguridad aprobado por Voltech. Para asegurar la seguridad del operario, este enclavamiento tiene que ser siempre conectado correctamente a un sistema de seguridad aprobado por Voltech.

Véanse detalles completos en el Capítulo 6 de este manual del usuario.

Este producto ha sido construido conforme con los requisitos de EN61010-1, Grado de Contaminación 2, y Categoría II de Instalación: SOLO PARA EMPLEO EN INTERIORES. Esto asegura la seguridad del instrumento y del usuario cuando se cumplen las precauciones normales de seguridad.

1.3.5. Istruzioni generali di sicurezza – Italiano

I dispositivi elettrici possono costituire un pericolo per la sicurezza. Spetta all'utilizzatore la responsabilità di garantire la conformità dell'impianto alle norme e alle direttive locali vigenti in materia. L'installazione di questo apparecchio deve essere affidata esclusivamente a personale qualificato dopo attenta lettura e comprensione del presente manuale. Attenersi alle istruzioni operative riportate in questo manuale. In caso di dubbi, contattare il proprio fornitore di zona.



PERICOLO! Rischio di scosse elettriche



AVVERTENZA: l'AT5600 deve essere collegato a una rete provvista di messa a terra di protezione.

Inserire il cavo di alimentazione solo in una presa munita di messa a terra di protezione. Controllare che il cavo di alimentazione sia integro prima di procedere all'utilizzo dell'apparecchio. Sostituire i fusibili solo con fusibili dello stesso tipo e amperaggio: 2.0AT 5X20 RITARDATO. Qualunque intervento sull'apparecchio deve essere affidato esclusivamente a personale qualificato in grado di comprendere il pericolo posto dalle scariche elettriche.



AVVERTENZA: l'AT5600 può generare tensioni potenzialmente LETALI.

L'interblocco di sicurezza è progettato per garantire la sicurezza degli operatori se utilizzato con un sistema di sicurezza approvato da Voltech. Per garantire la sicurezza degli operatori, questo interblocco deve essere sempre correttamente collegato a un sistema di sicurezza approvato da Voltech.

Per informazioni complete consultare il Capitolo 6 del presente manuale d'uso.

Questo prodotto è stato realizzato conformemente ai requisiti della norma EN61010-1, Grado di inquinamento 2, Categoria di installazione II: USARE SOLO IN AMBIENTI INTERNI. Ciò garantisce la sicurezza dell'apparecchio e degli utilizzatori a condizione che si adottino le normali precauzioni d'installazione e uso.

1.3.6. Algemene veiligheidsinstructies – Nederlands

Elektrische apparatuur kan een gevaar voor de veiligheid vormen. Het valt onder de verantwoordelijkheid van de gebruiker om bij de installatie de naleving van alle van kracht zijnde lokale voorschriften en wetten zeker te stellen. Deze apparatuur dient na het lezen en begrijpen van deze handleiding voor de gebruiker alleen door gekwalificeerd personeel te worden geïnstalleerd. Men dient zich te houden aan deze instructies voor de bediening. Bij twijfel kunt u contact opnemen met uw leverancier.



GEVAAR! Risico op elektrische schok



WAARSCHUWING: De AT5600 moet op een veiligheidsaarding (massa) worden aangesloten.

Steek de stekker van de netstroomkabel alleen in een contactdoos met een beschermend aardcontact. Zorg voor gebruik ervoor dat de netstroomkabel in goede staat verkeert en onbeschadigd is. Vervang de zekeringen alleen door hetzelfde type en vermogen: 2,0 AT 5X20 ANTISURGE. Laat onderhoud uitsluitend uitvoeren door gekwalificeerd personeel dat het risico op shockgevaren kent.



WAARSCHUWING: De AT5600 kan spanningen genereren die DODELIJK kunnen zijn.

De veiligheidsvergrendeling is ontworpen om de veiligheid van gebruikers zeker te stellen bij gebruik met een door Voltech goedgekeurd veiligheidssysteem. Om de veiligheid van de gebruiker zeker te stellen moet deze vergrendeling altijd correct zijn aangesloten op een door Voltech goedgekeurd veiligheidssysteem.

Zie Hoofdstuk 6 van deze gebruikershandleiding voor volledige bijzonderheden.

Dit product is gebouwd conform de vereisten van EN61010-1, Verontreinigingsgraad 2, en Installatiecategorie II: UITSLUITEND VOOR BINNENGEBRUIK. Hierdoor wordt de veiligheid van het instrument en de gebruiker wanneer men zich houdt aan normale voorzorgen gegarandeerd.

1.3.7. Generel sikkerhedsvejledning – Dansk

Elektriske anordninger kan udgøre en sikkerhedsrisiko.

Det er brugerens ansvar at sikre, at installationen overholder lokale love eller bestemmelser, der er i kraft.

Kun kvalificeret personale må installere dette udstyr, efter at de har læst og forstået denne brugervejledning.

Denne driftsvejledning skal overholdes. I tvivlstilfælde bedes du kontakte din leverandør.



FARE! Risiko for elektrisk stød



ADVARSEL: AT5600 skal være tilsluttet en jordforbindelse (jord).

Isæt kun strømledningen til en stikkontakt med en beskyttende jordkontakt.

Sørg for, at ledningen er i god stand og fri for skader inden brug. Udskift kun sikringer med samme type og effekt: 2.0AT 5X20 OVERSPÆNDING.

Vedligeholdelse må kun foretages af kvalificeret personale, som forstår risiciene for elektrisk stød.

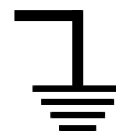

ADVARSEL: AT5600 kan generere spændinger, der kan være LIVSFARLIGE.

En sikkerhedslåsemekanisme er udviklet til at sikre sikkerheden for operatører, når den anvendes med et Voltech-godkendt sikkerhedssystem. For at sikre operatørens sikkerhed skal denne lås altid være korrekt tilsluttet et Voltech-godkendt sikkerhedssystem.

Du kan finde alle oplysninger i kapitel 6 i denne brugermanual.

Dette produkt er konstrueret i overensstemmelse med kravene i EN61010-1, forureningsgrad 2 og installationskategori II: KUN TIL INDENDØRS BRUG. Dette sikrer instrumentets og brugerens sikkerhed, når normale forholdsregler følges.

1.3.8. Allmänna säkerhetsanvisningar – Svenska

Elektriska enheter kan utgöra en säkerhetsrisk.

Det är användarens ansvar att se till att installationen efterlever alla gällande lokala lagar och förordningar.

Endast behörig personal får installera utrustningen efter att ha läst och förstått den här bruksanvisningen.

De här driftanvisningarna måste följas. Kontakta återförsäljaren om du är osäker.



FARA! Risk för elektriska stötar



WARNING: AT5600 måste vara kopplad till en skyddsjordning (jord).

Sätt endast i nätsladden i ett eluttag med en skyddande jordkontakt. Se till att nätsladden är i gott skick och inte har några skador före användning. Byt endast ut säkringar mot samma typ och märkning: 2.0AT 5X20 ANTISURGE. Service får enbart utföras av behörig personal som förstår risken för elektriska stötar.



WARNING: AT5600 kan generera spänningar som kan vara DÖDLIGA.

Säkerhetsföreglingen är utformad för att säkerställa operatörens säkerhet vid användning med ett Voltech-godkänt säkerhetssystem. Säkerhetsföreglingen måste alltid vara ordentligt ansluten till ett Voltech-godkänt säkerhetssystem för att säkerställa operatörens säkerhet.

Mer information finns i kapitel 6 i den här bruksanvisningen.

Den här produkten har tillverkats i överensstämmelse med kraven i SS-EN 61010-1, föroreningsgrad 2 och installationskategori II: ENDAST FÖR INOMHUSBRUK. På så vis säkerställs instrumentets och användarens säkerhet när normala försiktighetsåtgärder iakttas.

1.3.9. Yleiset turvallisuusohjeet – Suomi

Sähkölaitteet voivat muodostaa turvallisuusuhan. Käyttäjän vastuulla on varmistaa, että asennus on kaikkien paikallisten säädösten ja sääntöjen mukainen. Vain pätevät henkilöt saavat asentaa tämän laitteen tämän käyttöoppaan lukemisen ja sisäistämisen jälkeen. Näitä käyttöohjeita on noudatettava. Jos jokin on epäselvää, ota yhteys tavarantoimittajaan.



VAARA! Sähköiskuvaara



VAROITUS: AT5600 on liitettävä turvamaadoitukseen. Työnnä virtajohto vain pistorasiaan, jossa on suojaava maakosketin. Varmista ennen käyttöä, että virtajohto on hyvässä kunnossa ja ettei se ole vaurioitunut. Vaihda sulakkeiden tilalle aina samantyyppiset ja luokitukseltaan vastaavat sulakkeet: 2,0 AT 5 × 20 VIRTAPIIKKISUOJAUS. Teetä huoltotyöt aina pätevilla työntekijöillä, jotka ymmärtävät sähköiskujen vaarat.



VAROITUS: AT5600 voi synnyttää mahdollisesti TAPPAVIA jännitteitä. Turvalukitus on suunniteltu varmistamaan käyttäjien turvallisuus, kun sitä käytetään yhdessä Voltechin hyväksymän turvajärjestelmän kanssa. Käyttäjän turvallisuuden varmistamiseksi tämä lukitus on aina kytkettävä asianmukaisesti Voltechin hyväksymään turvajärjestelmään.

Lisätietoja on tämän käyttöoppaan luvussa 6.

Tämä tuote on valmistettu standardin EN61010-1, saastumisaste 2 ja asennusluokka II mukaisesti: VAIN SISÄKÄYTTÖÖN. Tämä varmistaa laitteen ja käyttäjän turvallisuuden, kun normaaleja varotoimia noudatetaan.

1.3.10. Obecné bezpečnostní pokyny – Čeština

Elektrická zařízení mohou být nebezpečná.

Je povinností uživatele zajistit při instalaci splnění všech platných místních právních předpisů.

Toto zařízení smí instalovat pouze kvalifikovaní pracovníci po prostudování a pochopení této uživatelské příručky.

Tyto provozní pokyny je nutné dodržet. V případě jakýchkoli pochybností se obraťte na dodavatele.



NEBEZPEČÍ! Riziko úrazu elektrickým proudem



UPOZORNĚNÍ: Zařízení AT5600 musí být připojeno k bezpečnostnímu uzemnění.

Napájecí kabel zapojte pouze do zásuvky s ochranným uzemňovacím kolíkem. Před použitím se přesvědčte, že je napájecí kabel v dobrém stavu a nevykazuje poškození. Při výměně pojistek používejte pouze stejný typ se stejným jmenovitým proudem: 2.0AT 5X20 ANTISURGE. Opravy a údržbu svěřte pouze kvalifikovaným pracovníkům, kteří chápou nebezpečí úrazu elektrickým proudem.

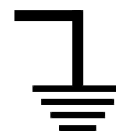

UPOZORNĚNÍ: Zařízení AT5600 může generovat napětí, která mohou být SMRTÍCÍ.

Bezpečnostní blokování je navrženo tak, aby zajistilo bezpečnost při použití s bezpečnostním systémem schváleným společností Voltech. Pro zajištění bezpečnosti obsluhy je nutné, aby toto blokování bylo vždy správně připojeno k bezpečnostnímu systému schválenému společností Voltech.

Podrobné informace naleznete v kapitole 6 této uživatelské příručky.

Tento produkt byl zkonstruován ve shodě s požadavky normy EN 61010-1, stupeň znečištění 2 a kategorie přepěťových instalací II: POUZE PRO POUŽITÍ VE VNITŘNÍCH PROSTORÁCH. Tím se zajistí bezpečnost zařízení a uživatele při použití běžných preventivních opatření.

1.3.11. Általános biztonsági utasítások – Magyar

Az elektromos készülékek biztonsági kockázatot okozhatnak.

A felhasználónak kell biztosítania, hogy a szerelés megfelel minden hatályos helyi jogszabálynak és előírásnak.

Csak szakképzett személyzet szerelheti ezt a készüléket e felhasználói kézikönyv elolvasása és megérése után.

Ezt a kezelési utasítást be kell tartani. Bármilyen kétség esetén, kérjük, forduljon a helyi szállítóhoz.



VESZÉLY! Áramütés kockázata



FIGYELEM: Az AT5600 készüléket biztonságosan le kell földelni.

Csak dugja be a tápkábelt a védőföldelő érintkezővel ellátott aljzatba. Használat előtt ügyeljen rá, hogy a tápkábel jó állapotban legyen, és ne legyen rajta semmilyen sérülés. A biztosítót csak azonos típusú és teljesítményű biztosítóval cserélje le: 2.0AT 5X20 ANTISURGE. A szervizt csak szakképzett személyzet végezheti, akik jól ismerik az áramütés veszélyét.



FIGYELEM: Az AT5600 nagy feszültséget generálhat, amely adott esetben HALÁLT okozhat.

A biztonsági reteszelés arra szolgál, hogy védje a kezelőket a Voltech által jóváhagyott biztonsági rendszer használata közben. A kezelő biztonsága érdekében e reteszelésnek mindig megfelelően csatlakoztatva kell lennie a Voltech által jóváhagyott biztonsági rendszerhez.

Kérjük, a részleteket olvassa el e használati utasítás 6. fejezetében.

E készülék megfelel az EN61010-1, 2. szennyezési fokozat követelményeinek, valamint a II. szerelési kategóriának: CSAK BELTÉRI HASZNÁLATRA szolgál. Ez biztosítja a berendezés és a felhasználó biztonságát a szokásos óvintézkedések betartása mellett.

1.3.12. Ogólne instrukcje bezpieczeństwa – Polski

Urządzenia elektryczne mogą stwarzać zagrożenie dla bezpieczeństwa. Obowiązkiem użytkownika jest zapewnienie zgodności instalacji z wszelkimi obowiązującymi lokalnymi przepisami lub regulaminami. Niniejsze urządzenie powinno być instalowane wyłącznie przez wykwalifikowany personel po zapoznaniu się i zrozumieniu niniejszej instrukcji użytkownika. Należy przestrzegać niniejszych instrukcji obsługi. W razie jakichkolwiek wątpliwości prosimy skontaktować się z dostawcą.



NIEBEZPIECZEŃSTWO! Ryzyko porażenia prądem elektrycznym



OSTRZEŻENIE: Urządzenie AT5600 należy podłączyć do uziemienia. Przewód zasilający należy podłączać wyłącznie do gniazdka z uziemieniem ochronnym. Sprawdzić, czy przewód zasilający jest w dobrym stanie technicznym. Wymieniać bezpieczniki wyłącznie na bezpieczniki tego samego typu i o tych samych parametrach: 2.0AT 5X20 ANTISURGE. Czynności serwisowe należy zlecać tylko wykwalifikowanemu personelowi, który rozumie zagrożenie porażeniem prądem elektrycznym.



OSTRZEŻENIE: Urządzenie AT5600 może wytwarzać potencjalnie ŚMIERTELNE napięcia. Zainstalowana jest blokada zabezpieczająca, aby zapewnić bezpieczeństwo operatorów podczas stosowania z systemem bezpieczeństwa atestowanym przez firmę Voltech. W celu zapewnienia bezpieczeństwa operatora blokada musi być zawsze właściwie podłączona do systemu bezpieczeństwa atestowanego przez firmę Voltech.
Szczegółowe informacje znajdują się w rozdziale 6 niniejszej instrukcji użytkownika.

Urządzenie AT5600 zostało zbudowane zgodnie z wymogami normy EN61010-1, stopień zanieczyszczenia 2 i kategoria instalacji II: **WYŁĄCZNIE DO UŻYTKU WEWNĄTRZ POMIESZCZEŃ**. Stosowanie właściwych środków bezpieczeństwa zapewni bezpieczeństwo urządzenia i użytkownika.

1.3.13. Genel Güvenlik Talimatları - Türkçe

Elektrikli cihazlar güvenlik tehlikesi oluşturabilirler. Bulunulan yerin yürürlükteki yasalarına ya da yönetmeliklerine uygun olarak kurulum yapılması kullanıcının sorumluluğundadır. Sadece bu kullanım kılavuzunu tamamen okuyup anlamış kalifiye kişiler bu cihazı kurabilirler. Cihazın çalıştırma talimatlarına her zaman uyulmalıdır. Emin olmadığınız şeyleri satıcınıza sorunuz.



TEHLİKE! Elektrik Çarpması Riski



UYARI: AT5600 cihazının mutlaka toprak emniyeti (topraklama) yapılmalıdır. Kablonun fişini sadece koruyucu topraklama hattı olan prizlere takınız. Kullanmadan önce elektrik fişinin iyi durumda ve hasarsız olduğunu kontrol ediniz. Sigortaları aynı tip ve aynı sınıf (2.0AT 5X20 ANTISURGE) sigortalarla değiştiriniz. Sadece elektrik çarpması risklerini bilen kalifiye elemanlara servis yaptırınız.

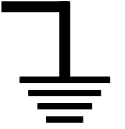

UYARI: AT5600, ÖLÜMCÜL olabilecek derecede voltaj üretebilir. Voltech onaylı güvenlik sistemleriyle birlikte kullanıldığında operatörlerin güvenliğini sağlamak için güvenli kilidi mevcuttur. Operatörün güvenliğini sağlamak için bu kilidin mutlaka Voltech onaylı güvenlik sistemlerinden birisine düzgün bir şekilde bağlı olması gerekmektedir.

Konuyu ayrıntılı olarak bu kullanım kılavuzunun 6. Bölümünde bulabilirsiniz.

Bu ürün, EN61010-1, Pollution Degree 2 (2. Kirlilik Derecesi) ve Installation Category II: FOR INDOOR USE ONLY (II. Kurulum Kategorisi: SADECE İÇERİDE KULLANILAN CİHAZLAR) standardının gerekliliklerine uygun olarak imal edilmiştir. Bu standart, normal güvenlik tedbirlerine uyulması koşuluyla cihazın ve kullanıcının güvenliğini garantiye alır.

1.4. Package Contents

When you receive your new AT5600, the following accessories will also be in the packing box.

Also given are the Voltech part numbers (VPN) in case you would like to order spares.

1 x Power Cord	VPN 77-000
1 x USB Editor Cable	VPN 77-077
1 x RS232 Editor Cable - 9W-9W	VPN 77-015
1 x RS232 Server Cable - 9W-25W	VPN 77-016
1 x Ethernet CAT5e cable Yellow 2M	VPN 77-060
1 x AT5600 Touch Screen Stylus	VPN 53-440
1 x AT5600 Screen Protection Accessories Set	VPN 100-128
1 x AT Series Safety Interlock Override Plug	VPN 91-156
1 x Certificate of Conformance	
1 x Certificate of Calibration	
1 x AT5600 Thermal Cycle Test Certificate	

If there is anything missing from this list when you first unpack your new AT5600, then please contact us for an immediate replacement.

2. System Overview

2.1. What is the AT5600?

The AT5600 is the latest model of AT series wound component testers from Voltech with improved performance. It shares the same fixture system and PC software so that legacy ATi's and AT3600's can share the same server, simultaneously recalling test programs and recording test results. This allows a seamless migration to the AT5600 to take advantage of all the benefits it has to offer.



AT5600

2.2. What is the AT5600 used for?

Your AT5600 is designed for fast, accurate and reliable testing of transformers and other wound components in a production or goods inwards environment. It is however a versatile instrument with many ways in which it can be set up and used.

It is important that you take the time to read this section and the overview in the following section to understand the product capabilities and make the best use of the AT5600 in your environment.

2.3. AT5600 Features Summary

Features:	ATi	AT3600	AT5600
20 way switching matrix	✓	✓	✓
PC test editor and results server	✓	✓	✓
Test fixture system	✓	✓	✓
Small signal tests e.g., inductance, capacitance,	✓	✓	✓
Telecoms. tests e.g., return loss, longitudinal	✓	✓	✓
Insulation resistance	500v	7000V	7000V
Hi-pot (AC)		5000V	5000V
Hi-pot (DC)		7000V	7000V
Surge testing		5000V	5000V
Magnetizing current and open circuit voltage		270V	270V
Watts, Stress Watts		✓	✓
Leakage Current		✓	✓
Hi-pot Ramp (AC)		5000V	5000V
Hi-pot Ramp (DC)		7000V	7000V
Ethernet (For networked communications)			✓
USB (For simple program editing and printing)			✓
Measurements optimized for accuracy and speed			✓
Fast stabilization of magnetizing current			✓
Audit Testing			✓
Diagnostic Testing			✓
Load Compensation			✓

Over 35 different tests are available for the AT5600.

Check our website at www.voltech.com for details of new tests.

Most can be installed within a few minutes by purchasing a software upgrade.

2.4. Front Panel Description

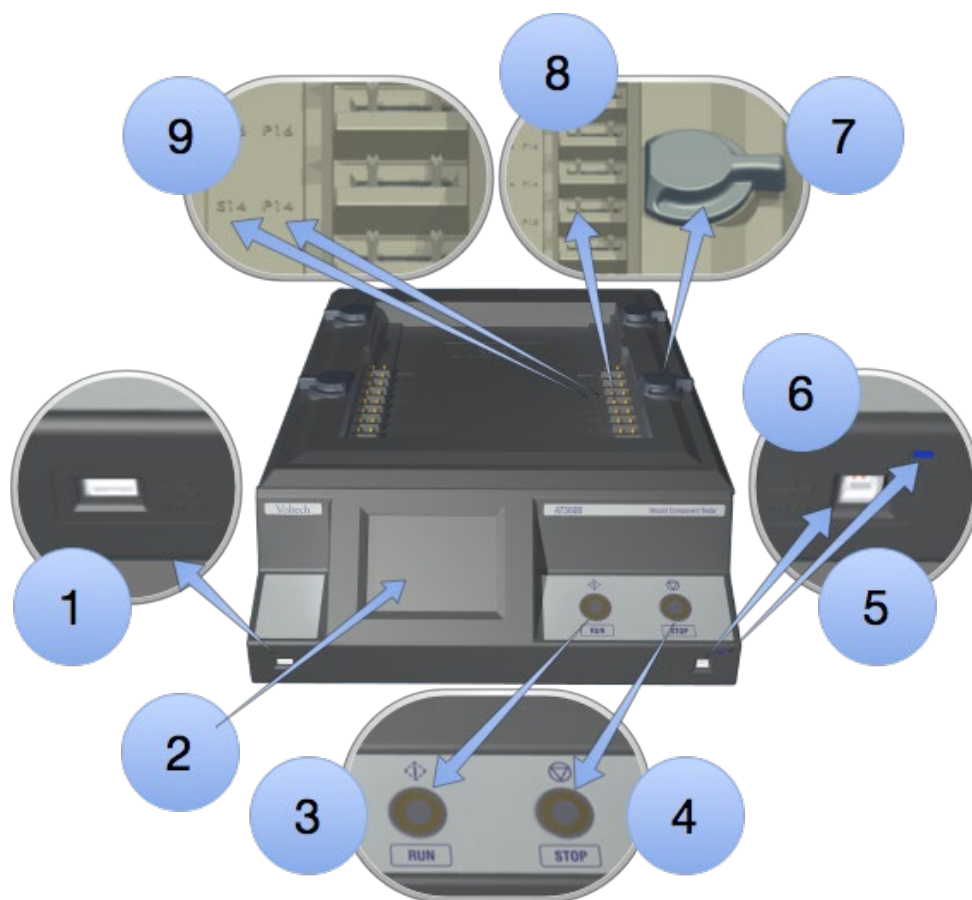

(1) Front USB 'A' connector

This allows printing of test results to an Epson TM-T88V USB Printer.

(2) Touch Screen Display

A Touch Screen colour LCD that provides the main user interface to the instrument. Do not use sharp objects to activate the touch screen. Use a finger or a touch screen stylus.

(3) RUN button and indicator

Press this button to start running a test program. A green indicator will illuminate around the button while measurements are being made.

(4) STOP Button and indicator

Press this button to stop running a test program. A red indicator will illuminate around the button when measurements have been stopped.

(5) Power Indicator

This indicates that the power supply to the instrument is switched on.

(6) USB 'B' connector

For connection to a computer used to control the instrument (usually using the Windows AT Editor software. Please see section 14.2.2 for instructions on installing USB drivers on your PC first).

(7) Locking Knob

For locking knobs are provided to lock down fixtures into the test bay.

(8) Spring Probes

Forty spring probes are used to make electrical connections with each node of the test fixture. Each node comprises of two spring probes to allow four wire (Kelvin) measurements.

(9) Sense and Power connections

Each of the twenty nodes has a sense and power connection. These are labelled on the test bay for easy identification. Separate sense and power connections allow for four wire (Kelvin) connections to the part under test so that test fixture connections are not included in the measurements.

2.5. Rear Panel Description

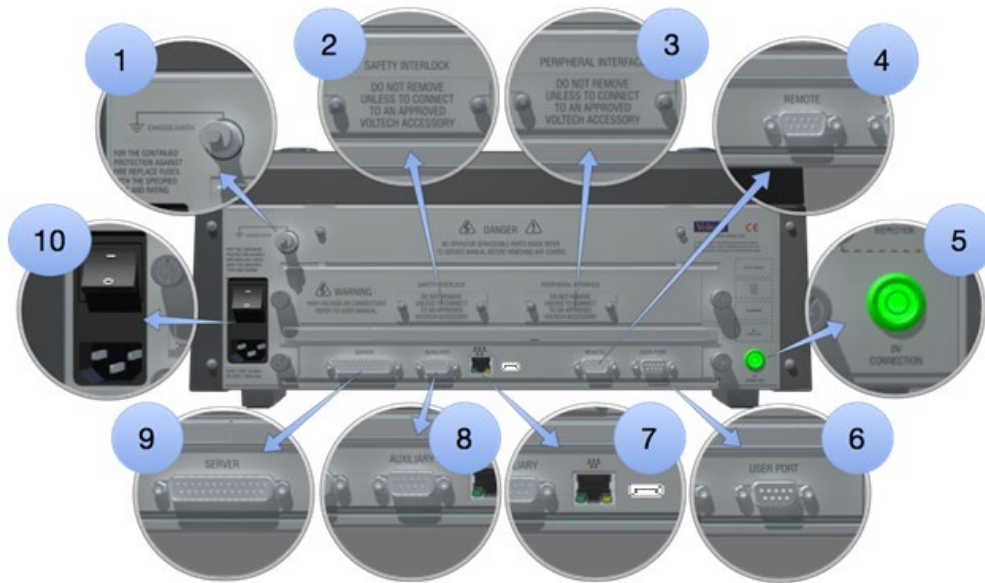

(1) Chassis Earth

Earth post for connection of the chassis earth when used with an unearthed mains connection. THIS EQUIPMENT MUST BE EARTHED.



(2) Safety Interlock

Supplied protected by a cover plate, this connects to a safety device, such as a light curtain. When the connection is broken the AT5600 cannot produce any dangerous voltages. HIGH VOLTAGE MAY BE PRESENT ($\leq 400\text{Vpk}$). See chapter 6, Safety Systems. To gain access to the port, remove the cover plate using a screwdriver as shown.



(3) Peripheral Interface

Supplied protected by a cover plate, this connects to Voltech accessories. HIGH VOLTAGE MAY BE PRESENT ($\leq 400\text{Vpk}$). See section 10.3.4, Peripheral Interface. To gain access to the port, remove the cover plate using a screwdriver as shown.

Removal and Replacement of a Cover Plate

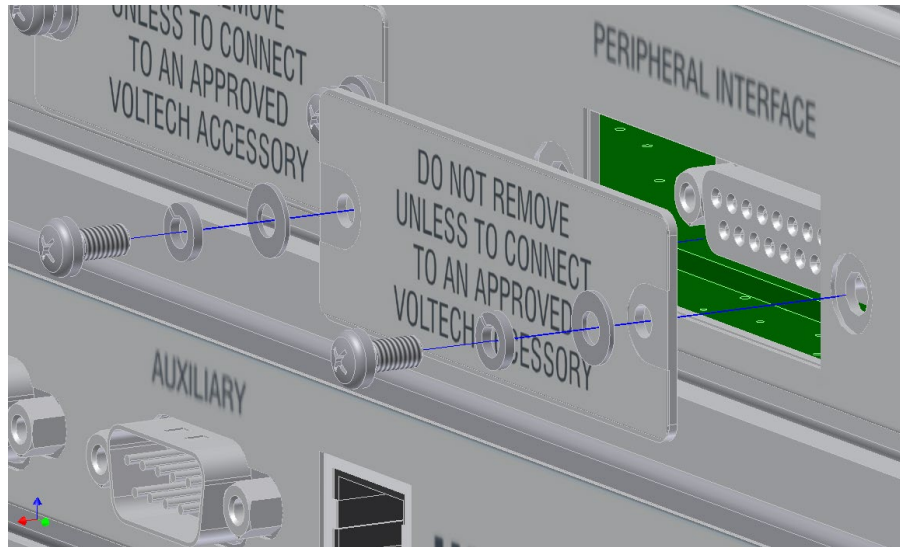
**(4) Remote Port**

The Remote Port is used to electrically signal the status and control the AT5600 allowing external indicators (Running/Pass/Fail) and control inputs (Run/Stop). For more information see 10.3.3

**(5) Chassis Terminal (0V)**

This is the AT5600 chassis 0V potential and it used when connecting peripherals that need to reference the signal potentials. It is a 4mm Banana socket connection. THIS SOCKET IS NOT TO BE USED TO EARTH THE AT5600.

(6) User Port

The User Port provides open collector style outputs that are used as electronic switches for control of additional relays and other devices. For more information see 10.3.6 and 7.26

(7) Rear USB 'A' connector and Ethernet Port

This allows printing of test results to a USB Epson TM-T88V Printer.

The Ethernet Port provides a 10/100 Ethernet Network connection for communication with the AT5600 using the TCP/IP protocol. This is the recommended method for communication with the Voltech AT Series Server Software.

(8) Auxiliary Port

This RS232 serial port is used for connection to external peripherals or a computer system running the Voltech AT Series Editor software.

(9) Server Port

This RS232 serial port is used for connection to a computer system running the Voltech AT Series Server software. It is normally only used for legacy connections where an AT5600 is being used to replace an AT3600 or ATi.

(10) Power Switch and Disconnection Device

Switches the unit on and off by breaking the mains power to the unit. No power is drawn from the supply when switched off. Connect the power outlet to this socket using the supplied power cord or equivalent to IEC60320 C13 type with 3A minimum current capability and voltage rating greater or equal to the mains supply voltage. Contained within the module are two fuses which must always be replaced, when necessary, with the same type and rating (2.0AT 5X20 ANTISURGE).

2.6. Air Circulation

The AT5600 has air vents in both sides that draw in and expel air to keep the internal components cool.

These vents must not be obstructed.

Do not place any other equipment within 50mm of all vent openings.

Side Vents

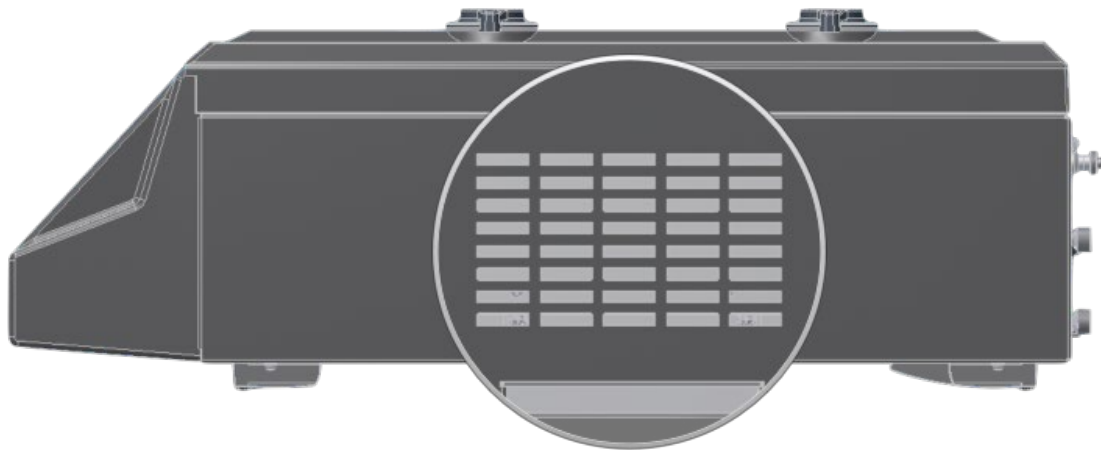

If the vents are obstructed then the AT may overheat, displaying an over temperature warning message. This message may also be shown if the air filters become blocked.

See the Maintenance chapter, section 11.1, Air Filters, for more information.

2.7. Tilt Feet

To improve the visibility of test pins under certain operator seating arrangements, or to give the AT5600 the same tilt as the AT3600, the rear feet may be tilted.

Tilting the feet

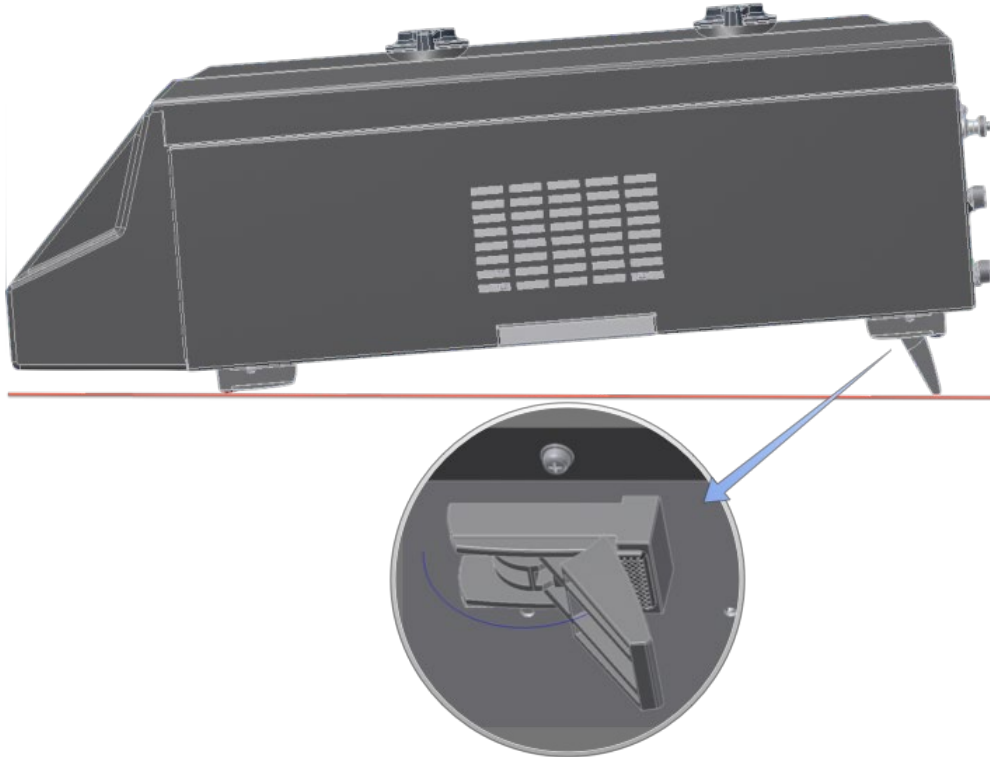

2.8. Lifting Points



Two lifting points (one for each hand) are provided beneath each side vent.

Always remove any fixture and other accessories fitted before lifting.

Lifting should be done from the rear (to minimize the distance from the body) with the fingers of each hand placed inside the recesses.

Always follow good manual handling practices. If you are unsure of how to safely lift this product, then please consult your health and safety information.

For handling, the weight of this product should be taken as 19 Kg.

See section 10.5 for full weight and dimension information.

2.9. A Typical Installation

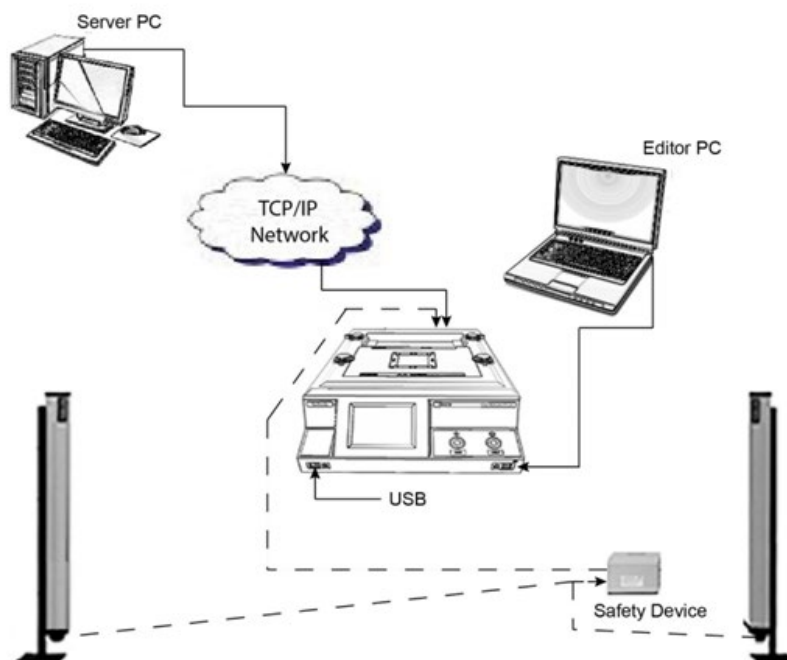

IMPORTANT

the Editor and Server PCs are shown separately in the above as they are different software. However, both packages can be run from the same PC.

Both the Editor and Server can also access programs from (and save results to) any standard network drive for security, storage and back up in the event of a local PC failure.

2.9.1. Server PC – results and test program management

Windows based Server software for easy management of all test programs.

(See chapter 15, AT Series Server Software)

2.9.2. Editor PC – test program development

- Simple, easy to use, Windows based Editor for creating test programs. (See chapter 14, AT Series Editor Software)
- Requires no software programming skills or expertise.
- Test conditions may be entered manually or chosen automatically by measuring a sample transformer.
- Up to 150 user tests per program.

2.9.3. Test Fixture

The test fixture acts as an interface between the spring probes of the AT5600 and the part under test. They can be made to order or easily customized from standard fixture kits to allow fast and efficient contacts to be made. See Chapter 13, Test Fixtures.

2.9.4. Light Curtain (or another safety device)

A safety device is required to prevent an operator from touching any live wires during high voltage testing. The AT5600 includes a Safety Interlock connector on the rear panel. The safety interlocks must be properly connected before any high voltage test can execute.

For manual operation, if high voltage tests are required, the Voltech safety system is recommended. This is based around the use of Infra-Red-light beams to provide a safety curtain and has the advantage of not slowing test throughput.

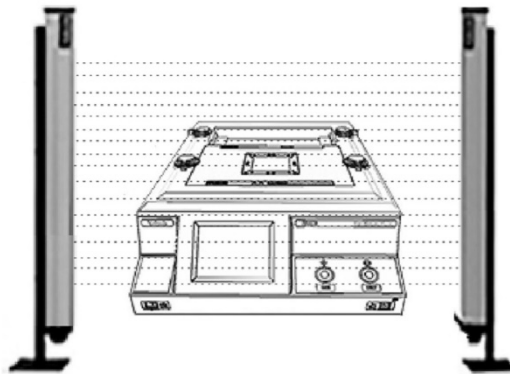

For more information on safety systems, see chapter 6, Safety Systems.

3. Using the AT5600

3.1. Usage Overview

The following activities must be carried out to use the AT5600 to test components.

Create a test fixture. The fixture is required to reliably connect the component under test to the AT5600.

Develop a test program. Use the AT Editor software to develop a suitable test program for the component under test.

Store the test program for retrieval by the AT5600.

Load and run the test program.

Store and analyse the test results.

3.2. Test Fixtures

The AT Series has been designed with its own test fixture system to make connections to a huge array of different component footprints.

1. Fixtures are constructed on a standard 'fixture board' which fits into the top surface of the tester.
2. The fixture system uses Kelvin connections to give the best possible measurements when testing wound components.
3. The fixture system will accommodate diverse types of connectors suitable for both PCB mounting and flying lead transformers.
4. A single test fixture can be used for all transformers wound on the same bobbin.

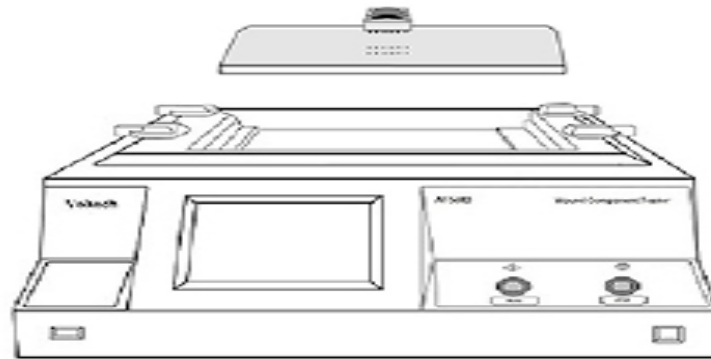

As well as the standard fixture system, custom fixtures are available from Voltech partners. Please see the Voltech website www.voltech.com for more information.

For details of the Voltech fixture system, please see chapter 13, Test Fixtures.

3.3. Creating Test Programs - AT Editor

The test program is simply the list of tests to be performed on a wound component.

Individual parts should each have their own test program, and as an example, a typical program for a three-winding switch-mode power supply transformer could be as follows:

Program:

Resistance	W1
Resistance	W2
Resistance	W3
Inductance	W1
Turns Ratio	W1 to W2
Turns Ratio	W2 to W3
Hi-Pot	W1 to W2 + W3

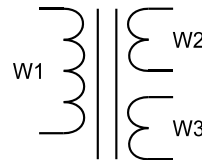

Part Number: SMPSE42-A

The Test Program Editor supplied with the AT5600 allows the creation of test programs simply and easily without any need for software programming skills. Each test required for the program is selected from a list of 'available tests' by clicking with the mouse. The test details (such as the transformer terminals, test conditions, and pass / fail limits) are then entered into the dialogue box.

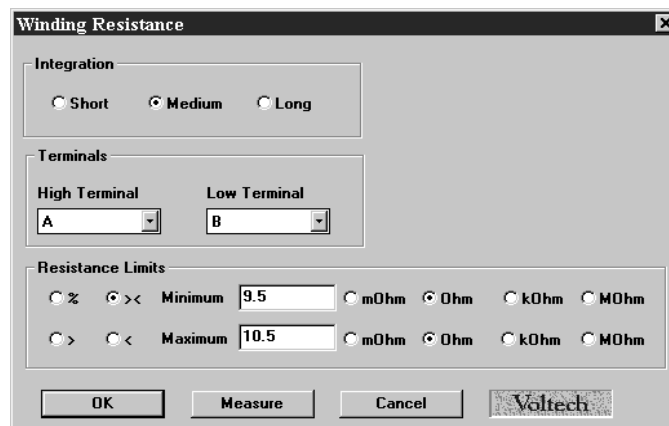

Normally, the Editor Software communicates with the AT5600 using the USB connection. It can also be used with the Auxiliary Port of the Tester connected to a spare RS232 Com-Port on the PC.

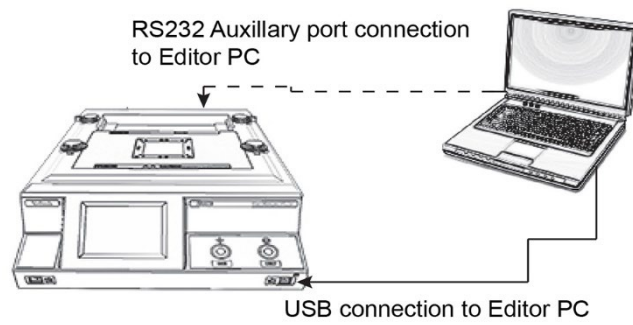

Simple controls in the Editor then allow you to create a test program by performing measurements, setting limits, and downloading the program to the tester. Programs are stored on the Server for later retrieval. For full details of the AT Editor Software, see section 14, AT Series Editor Software.

3.4. Utilizing Editor Test Programs

The AT Editor software (section 14) allows you to create and evaluate each individual test program. It is not intended to manage the large numbers of test programs that may be required daily once they are in 'production' use. Store the program in the AT Server program directory once a program has been developed. It shall then be made available to the AT5600 to load up and be ready to run through the AT5600 user interface.

The Editor software can also be used to send the test program directly to the Server store via the AT5600, or to save the file directly to the server program directory (either over a network or on the same PC).

3.4.1. Storing programs on the Server

One of the software packages supplied with the AT5600 is called the AT Server. Usually, the Server software is installed onto a PC which is left on during operating hours to distribute test programs to AT5600(s) as well as to log all test results.

The AT5600 has a 'Server' port on its rear panel for connecting to the Server using an RS232 COM port, but normally connection is made over a TCP/IP network utilizing the Ethernet interfaces present on the computer and the AT5600.

Server and Editor on separate computers

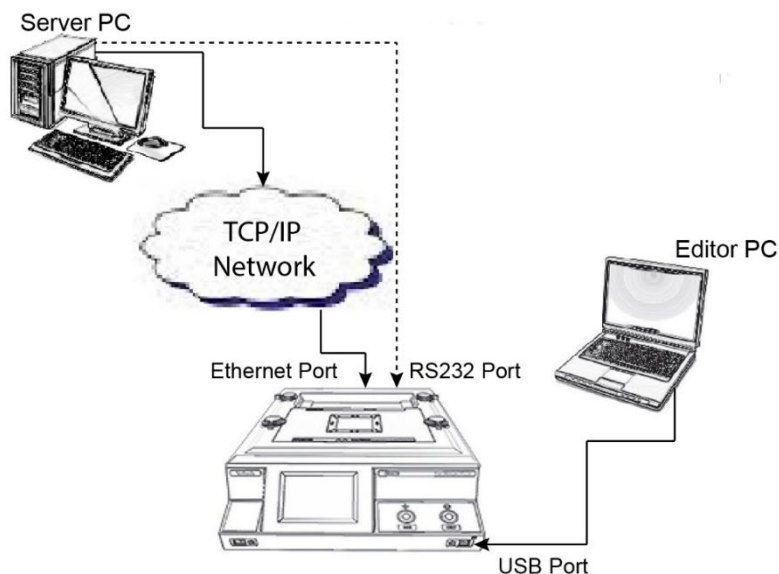

Transferring programs to the Server

Transferring a new test program from the Editor to the Server can be done in any of the following ways:

- Directly from PC to PC via an external disk/network connection
- Via a network connection between the PC's using 'Save As' in the Editor to transfer the program to the directory used by the Server for programs.

With both Server and Editor installed on the same computer

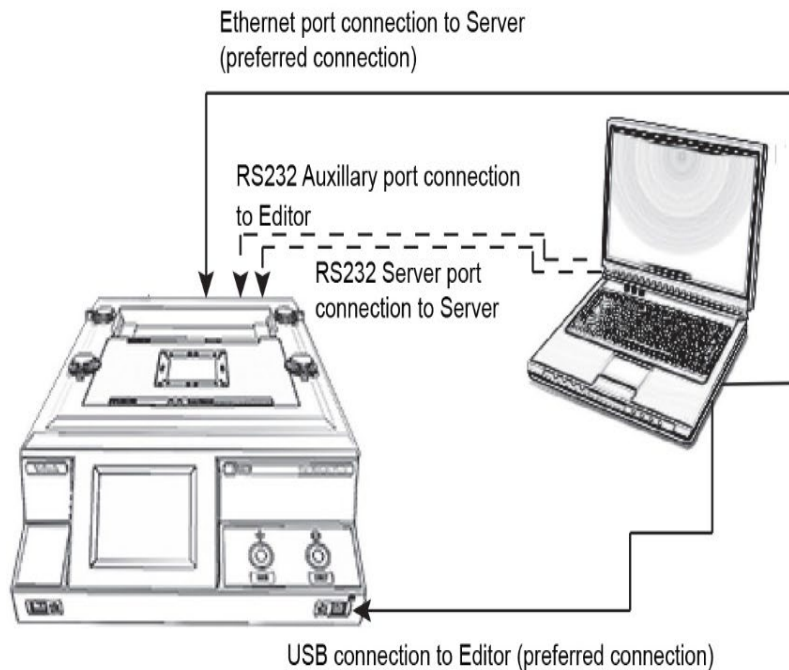

With the Editor and Server installed on the same PC, configuring the Server to use the same default program folder as the Editor is recommended. This way all the test programs are immediately available for use by the Editor and Server.

3.5. Results Printing

The AT5600 can be configured to automatically print results at the end of each program run and the results can be printed using the PRINT soft key through the user interface as detailed in Section 8.

Automatic printing is configured as part of the test program using the Editor software. Please see section 14.5.1, "Setting the Program Options", about automatic printing configuration.

All printing has been tested using the Epson TM-T88V printer. This is a very high-speed printer with print speeds up to 300mm per second.

Although other compatible models may work correctly, Voltech can only guarantee operation with this printer.

See Section 5.5 USB Printer Setup for complete instructions to set-up the Epson TM-T88V printer including changing to USB Printer Class.

3.5.1. Report Format

The format of the print output uses simple characters to maximize the speed of printing. ASCII characters are used using a fixed width font to give a consistent presentation. The width of the print is 56 characters and centralized to the printer paper.

```

-----
|                               VOLTECH INSTRUMENTS                               | - Note 1
|                               AT5600 PART UNDER TEST REPORT                       |
|                                                                              |
|S/N:          100011200016           | - Note 2
|F/W:          0.007.053              | - Note 3
|OPERATOR:    TEK                     | - Note 4
|BATCH:       015                     | - Note 5
|PART NUM:    INDUCTOR                 | - Note 6
|PART S/N:    X00058                   | - Note 7
|DATE:        18-DEC-16 10:34:43      | - Note 8
|RESULT:      *** FAIL ***             | - Note 10
-----
| ID  TYPE  MINIMUM  MAXIMUM  RESULT  P/F  |
| 1   R     80.00mΩ  100.0mΩ  90.66mΩ  P 0000 | - Note 9
| 2   LS    2.000uH   6.000uH   4.403uH  P 0000 |
| 3   QL    20.00    30.00    31.45    F 0000 |
|                                     *** FAIL ***                               | - Note 10
-----

```

Note:

1. The report title.
2. The serial number of the AT5600 that is printing this report.
3. AT5600 Firmware Version.
4. The operator name as entered at the start of the batch. This line is omitted if no operator name has been entered.
5. The batch number as entered for this part. This line is omitted if no batch number is set.
6. The part number being tested.
7. The serial number of the part under test. This line is omitted if the serial number is not set.
8. The date and time of the test (only shown if date and time on reports is selected. Please see section 14.5.1 about setting the options).
9. A result line is shown for every test in the program. The last 4 digits show the status code for the result.
10. The overall result can be PASS or FAIL.

3.6. Recommended Configuration

The standard installation in a large production facility could use several testers, together with a Server PC for test program and results archive:

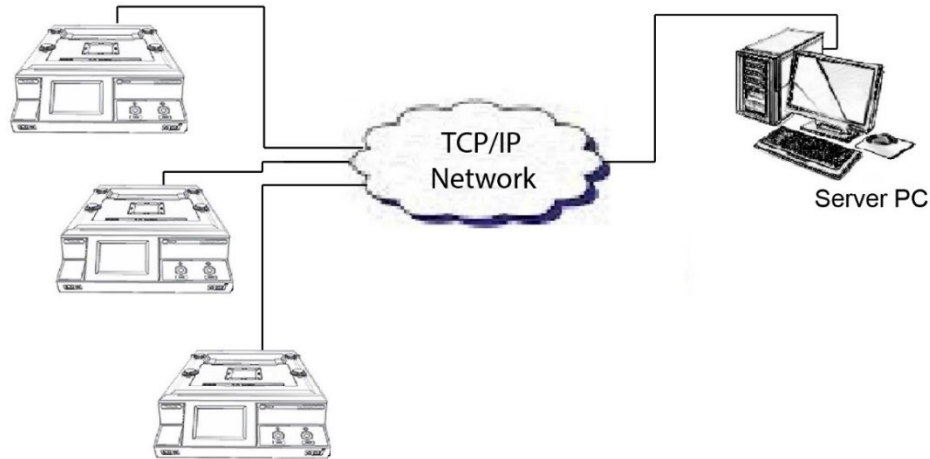

Advantages

- Convenient storage and management of large numbers of test programs (e.g., >1000).
- Easy storage and management of test results.
- Importing results into other Windows applications for analysis.
- The Server PC on a Network could be located away from the test area, for example in a supervisor's office, allowing results analysis to be performed where it is required.
- Up to 8 AT Series testers may be connected to each Server PC

Limitations

- Requires the Server PC to be permanently connected and running. This is to allow the tester uninterrupted access to the server, for the purposes of accessing programs and storing results.
- Usually requires an additional PC (which could be a portable) to be attached locally to (the USB or Auxiliary Port) one of the AT testers when a new program needs to be developed and evaluated.
- .

3.7. Operating the AT5600 in Production Test

The AT5600 has been designed to work in both manual and robotic production situations.

3.7.1. Manual Use



In manual use, the tester is simply placed on a work surface in front of the operator and connected to a PC running the AT Server software as described previously.

3.7.2. Robotic Operation

In robotic situations, the tester's Remote Port provides signals for control systems. For interface details see 10.3.3

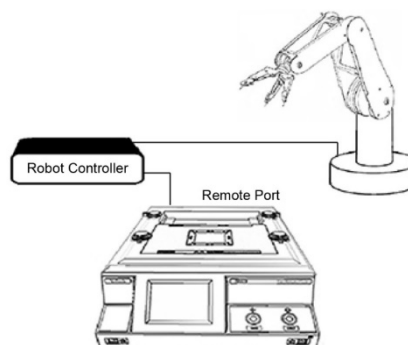

The AT5600 shall be connected to a Server PC to allow the option for full statistical process control – results can be used to adjust and check manufacturing parameters.

4. AT5600 Functional Description

4.1. Behind the Front Panel

It is not necessary to understand the operation of the AT5600, but it may be of interest as well as helping to understand its capabilities and to troubleshoot measurement problems.

The internal functionality of the AT5600 tester is summarized below:

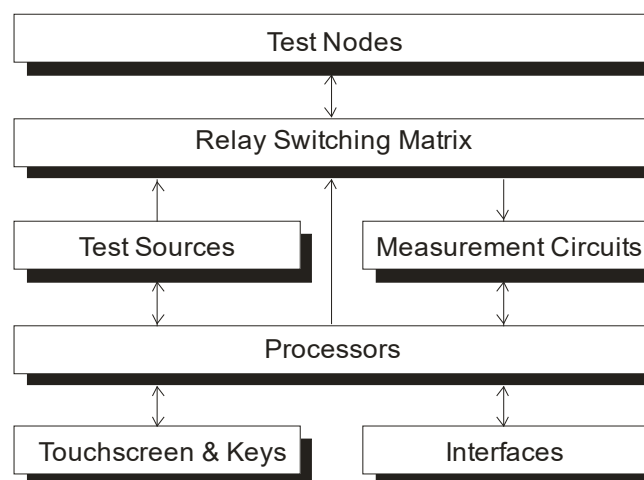

You do not need to know how each block functions to use the tester. The following explanation is included for users who wish to understand more.

4.1.1. Test Nodes

These are the spring-loaded ATE pins that can be seen on the top surface of the tester. Each node is made up of two contacts - a 'power' pin, and a 'sense' pin - forming a Kelvin pair.

4.1.2. Relay Switching Matrix

The purpose of the relay-switching matrix is to connect the selected test source and measurement circuits to the nodes required in the test.

The matrix is a crucial component in the performance of the AT5600. It is made up of very advanced, high speed, high voltage reed relays, capable both of holding off the 7000V test voltages used in Hi Pot tests, and of accurately switching the exceedingly small voltages and currents encountered in other tests.

The switching of the relays is carefully controlled by the processors so that there is no arcing across the contacts. This means that the life of the relays can be guaranteed to last for many millions of switching operations.

4.1.3. Processors

The AT Series Testers are based on a two-processor design:

- A standard microprocessor which acts as controller, controls the test sources, and drives the relay matrix, the keyboard and display, and the various interfaces.
- A fast-digital signal processor that performs the measurements.

4.1.4. Test Sources

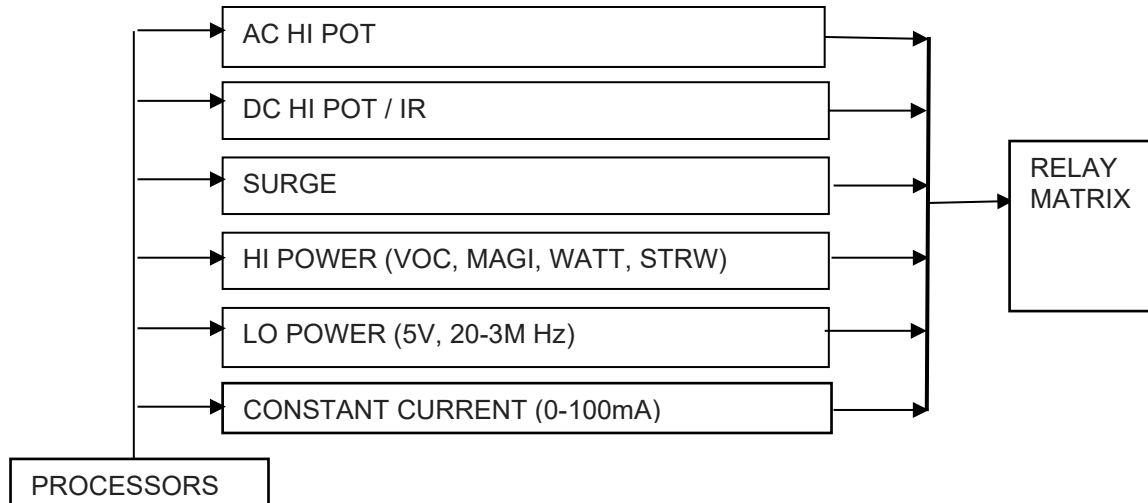

There are six different test sources within the AT5600. The processors select which one is to be connected to the relay matrix as each test is executed.

Low Power Generator – 50 Ohm impedance

The Low Power Generator can produce up to 5 V rms and contains 50 Ohms source impedance.

Limit on Test Voltage

The maximum Test Signal which can be delivered depends on the load connected to the source. The maximum Test Signal shall be.

$$V_{out} = V_{LPG} * [Z_{Load} / (Z_{Load} + R_{50\Omega})]$$

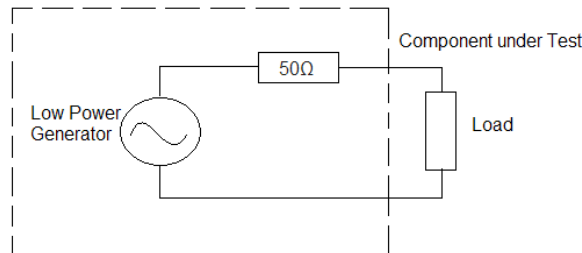

E.g. - A “LS Test” to measure a component with a nominal impedance of 500Ω
The maximum Test Signal that can be programmed is.

$$V_{out} = 5V * [500 / (500 + 50)] = 4.55 V$$

Limit on Test current

The maximum current obtainable from the LPG, given an ideal load is
 $= V / R$
 $= 5 \text{ Volts} / 50 \text{ Ohms}$
 $= 100 \text{ mAmps}$

This test current can be further limited by the impedance under test and frequency at which you test. Please see individual test sections in section 7 for advice on choosing best test conditions, which will maximise the test current and hence give the best, most repeatable readings.

4.1.5. Measurement Circuits

The AT5600 tester contains a variety of circuits, capable of performing all the following measurements:

- Voltages from less than 1mV to greater than 7000V
- Currents from nano-amps to amps
- DC and harmonic analysis
- RMS, mean-sense, wattage, and VA analysis.

Again, the processors select which is appropriate for each test as it is executed.

4.1.6. Touch Screen & Buttons

The front-panel of the tester contains a colour LCD graphics touch screen display, a RUN button and STOP button.

To give the greatest versatility and ease of use, a touch screen menu system is based around 'soft keys,' which are situated on the right of the display. During operation, the display shows the function of these keys, allowing them to change with the context, so that the operator is presented with only the choices that are relevant at that point in time.

Instructions to the operator are always shown in the main display area.

This will communicate what should be done, and what options are available, including the functions of the RUN and STOP buttons.

4.1.7. Interfaces

The AT5600 Interfaces include the USB ports, Ethernet, Remote, Auxiliary, User Port and Server Ports. See section 10.3 for full interface specifications.

4.2. How Does the AT5600 Tester Run a Test?

Programming of each test is done at a high level; it is not strictly necessary for you to know the details of how tests are executed within the tester. However, for some users this subject may be of interest, therefore a brief explanation has been included here.

When the test program is loaded into the tester, each individual test is assembled into a sequence of operations involving the components in the functional block diagram shown in 4.1-1. The sequence is different for each test, and in some cases, it depends on which is the preceding and following tests in the program; but in all cases, it is optimized to give the best measurement speed and accuracy.

As an example, the sequence for measuring inductance may be summarized as follows:

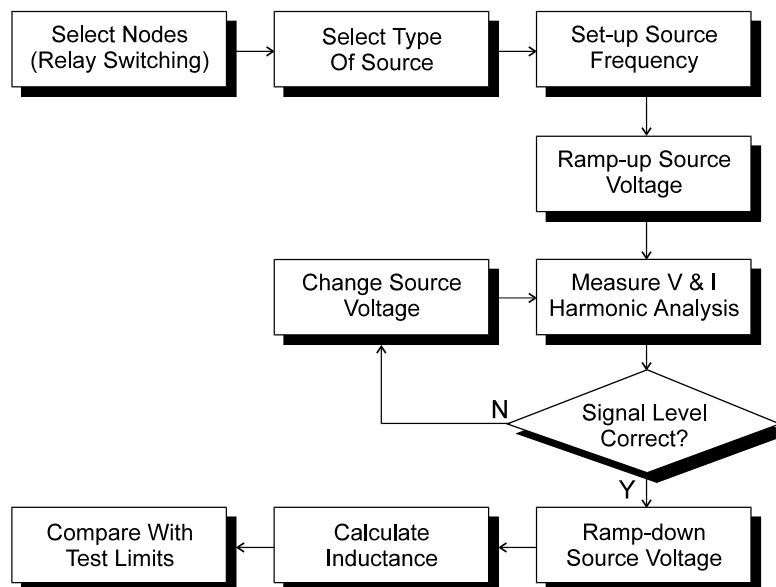

For other tests, the sequence may be more complicated.

Notes: All the relay switching is completed before the test source is energized; this will ensure that there can be no arcing and prolong the life of the relays.

In contrast to some LCR bridges, the AT Series testers trim the test source to give the user programmed test conditions. This will guarantee that the same test conditions are applied to all transformers that use the same test program.

At the end of the test, the source is safely ramped down, so that the relay switching for any subsequent test will always occur with the source removed.

5. Getting Started

5.1. Installing the AT5600

Place the tester on a suitable work surface in the position where it is to be used. Refer to section 2.9, A Typical Installation, for an overview of installation requirements.

Before deciding on the exact location, it may be useful to refer to chapter 6, Safety Systems, which describes a safety system to protect operators from the high voltages which may be present on the components under test.

Switch on the supplies to the PC.

Ensure that the top surface of the tester is not fitted with any test fixture, and nothing is touching any of the test nodes. Connect the tester's line input to the available supply and switch on.

You must connect the power lead to a socket with a safety ground contact.

For operation of the AT5600, a safety interlock must be properly connected as detailed in chapter 6, Safety Systems.

As with any measuring equipment, the unit must be powered on for at least 30 minutes to become thermally stable, and SELF TEST run to confirm unit integrity.

5.2. Installing the Windows Software

Install the Editor software as in section 14.2, “Installing the Editor Software,” and configure the communications port to control the AT5600 as in section 14.3.3. Communication Configuration

5.3. Install the Server Software

The Server software is normally installed on a different PC from the Editor software, The Server PC needs to be permanently connected to the AT5600 to download programs to the AT5600 and to save test results.

Follow the instructions “Starting for the first time,” in section 15.3.

The Server software must be installed and operational to follow the server functionality in the quick start tutorial.

5.4. Quick Start Tutorial

After you have installed the AT5600 together with the editor and server software packages as described in section 5.2 and 5.3, you may wish to follow through this tutorial to familiarize yourself with the system operation.

This tutorial will guide you through the process of creating a schematic and test program using the Editor software. The program you will create will only run if your tester has been installed with the tests used.

5.4.1. Creating a Simple Schematic

This tutorial describes a method of setting up the tester to test a two-winding transformer with the following specification:

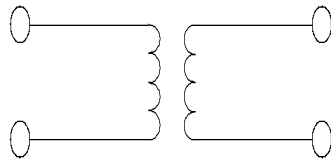

Resistance of winding AB	59-73 OHMS
Resistance of winding CD	59-73 OHMS
Inductance of winging AB	>3H
Turns ratio AB to CD	1:1 +- 2%

Start the editor program by double-clicking with the left mouse button on the editor icon, the first thing to do is to 'draw' a schematic of the transformer to be tested.

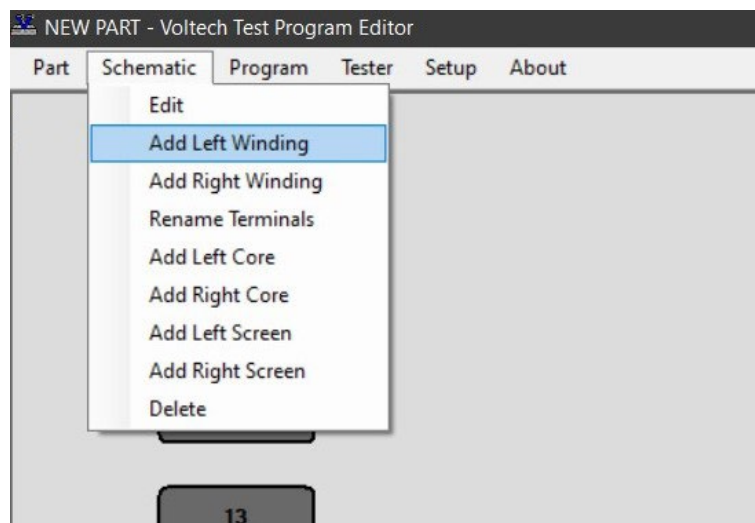

1. Using the left mouse button, click on 'Schematic' on the Top-Level menu bar, and select 'Add Winding' from the menu.

You will now see a winding with two terminals, floating below the mouse pointer. Place the winding on the left-hand side of the screen and press the left mouse button.

2. A dialogue box will ask you to name the terminals of the winding; the cursor will be in the box for Terminal 1. Type the name of the Terminal 1 (e.g., 'A').
3. Press TAB to move to the Terminal 2 box or right click on the Terminal 2 box and type the name of the second terminal (e.g., 'B') in that box. Then click OK or press [Enter].

Repeat steps 1-3 to create a second winding.

This time place the winding on the right-hand side of the screen, a mirror image of the first winding, and use different terminal names (e.g., 'C' and 'D'). The screen should then look like this:

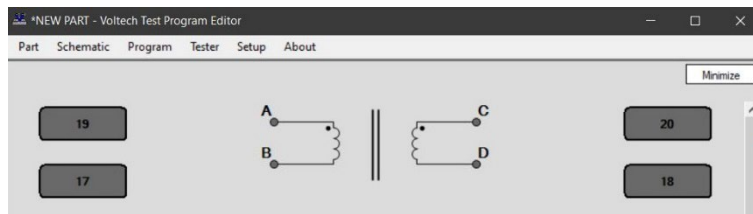

Now, connect the windings to the test nodes of the tester:

Place the mouse pointer over terminal A; press and hold the right mouse button. Continue holding the mouse button down and drag the mouse pointer to test node 9. Release the button. A wire will now connect terminal A to test node 9. Repeat this procedure to connect the other three terminals, B, C and D to nodes 7, 10 and 8. The screen should now look like this:

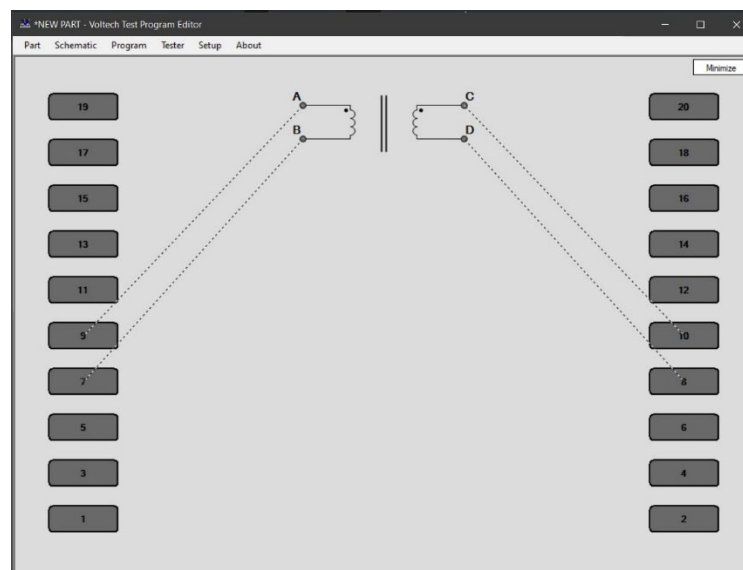

You have now created a schematic layout of a four-terminal transformer.

5.4.2. Creating the Test Program

After creating the transformer schematic, you may now create an example program, containing the following four tests:

Resistance of winding AB (1 mΩ to 209 mΩ)

Resistance of winding CD (171 mΩ to 209 mΩ)

Inductance of winding AB (>330 uH)

Turns ratio AB to CD (1:1 ± 2%)

1. Set up the program options:

From the top-level menu bar select: **'Program'** menu, then select **'Options.'**

The following dialogue box will appear:

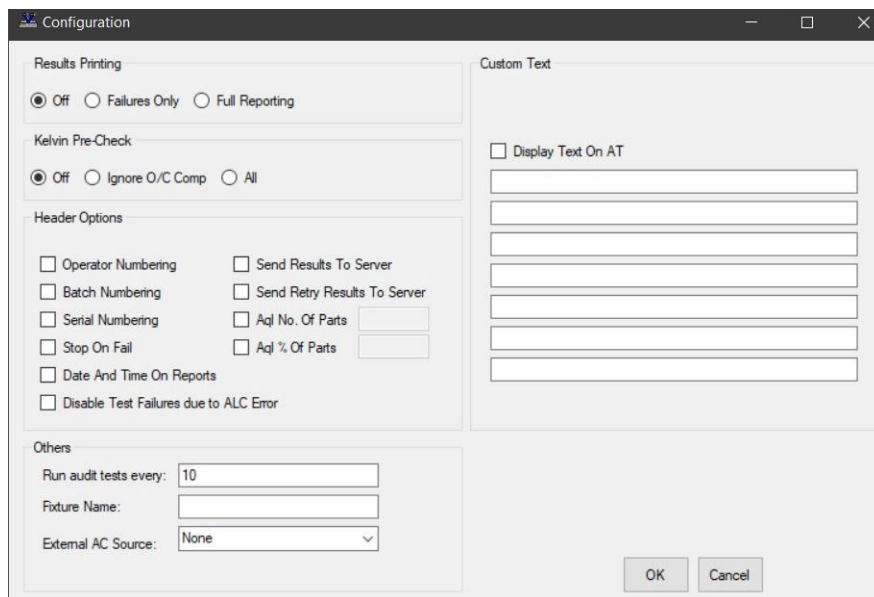

Using the left mouse button, click to enable the following option.

'Send Results to Server'

In the Fixture ID box, enter the name:

'UNIVERSAL'

Click on **'OK'** or press [Return] to accept the changes and close the dialogue box.

2. Create the test program:

From the Top Level **'Program'** menu, then select **'Edit.'**

The screen will now be made up of three Windows.

Top left: The schematic window showing the two windings.

Right side: The available tests window listing all the tests available on your AT5600. (Any test that is not available shall be greyed out).

Lower left: The Program window displaying the tests programmed so far.

There are three tabs, General Tests, Audit Tests, and Diagnostic Tests

- General Tests
- Audit Tests
- Diagnostic Tests

In the lower left window, select the tab labelled 'General Tests.' Next, double click the left mouse button on the 'R Winding Resistance' from the 'Available Tests' window. The following dialogue box will appear.

Enter the terminal names. Input 'A' as the high terminal and 'B' as the low terminal, moving between the fill-in boxes using the TAB key or right clicking in the desired box. Now enter the resistance limits. This can be done in four ways:

- % Click on this button to enter a nominal value with a percentage tolerance (for example, 190 mΩ with 10% tolerance),
- >< Click on this button to enter minimum and maximum values (for example, 171 mΩ and 209 mΩ)
- > Click to enter just a minimum value (for example, > 171 mΩ),
- < Click to enter just a maximum value (for example < 209 mΩ).

In this example, the >< limits will be used:

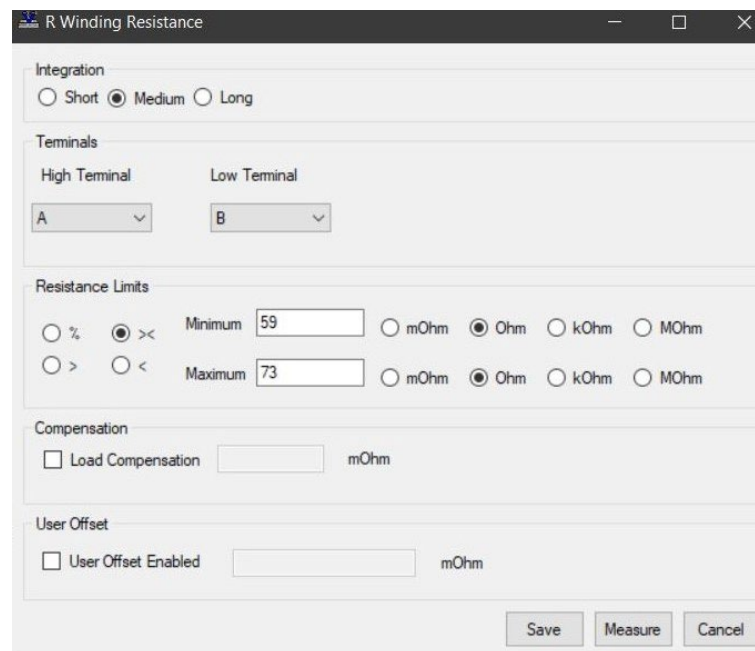

(The 'Ohm' unit button is selected by clicking the radio button with the mouse.)

If the "User Offset Enabled" check box is checked, a value can be entered into the edit box. The value entered (in the units shown) is then added to any results returned from the AT tester. This function can be used to adjust for measurement fixture effects that cannot be compensated for or to compensate the fixture manually, so a compensation stage is not required to obtain the correct readings.

Click on the 'OK' button. The test and its parameters will now appear in the 'Program' window.



Add the second test by double clicking the left mouse button, select 'R Winding Resistance' from the 'Available Tests' window.

At the dialogue box, enter the data as before; this time for the second winding:

- Integration (Leave as the default - **Medium**)
- High terminal **C**
- Low terminal **D**
- Minimum **20 mΩ**
- Maximum **171 mΩ**

Click on the 'OK' button. Again, the test and its parameters will appear in the 'Program' window.

Add the third test by double clicking the left mouse button, select 'LS Inductance (Series Circuit)' from the 'Available Tests' window.

At the dialogue box, enter the data required for the inductance test:

Signal **1V** (again choose the V units button by clicking with the mouse)
 Frequency **50Hz**
 Integration (Leave as the default - **Medium**)
 High terminal **A**
 Low terminal **B**

Click on the '>' button to select a minimum limit only, and enter:

Minimum **330 uH**

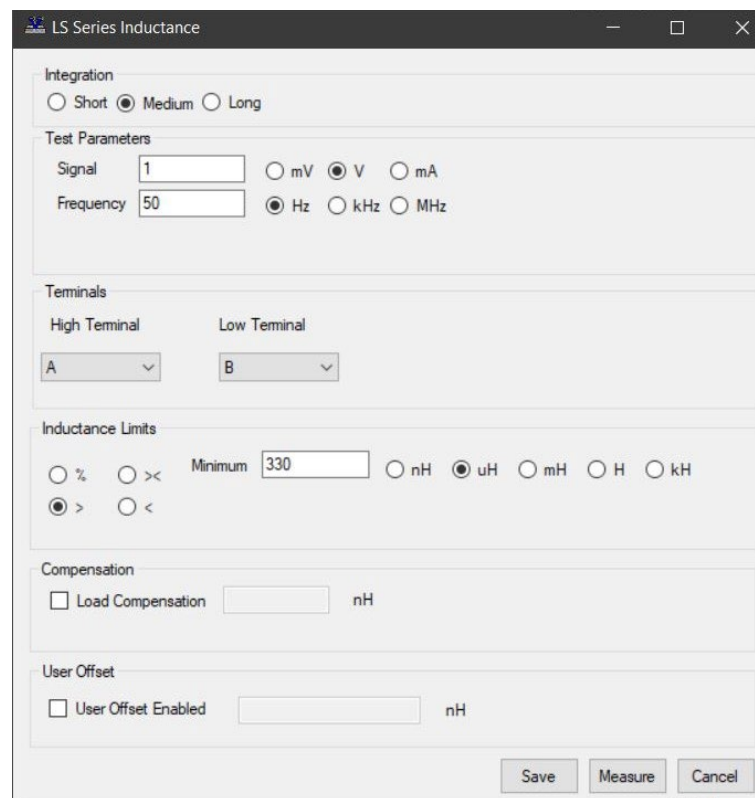

Click on the 'OK' button. Again, the test and its parameters will appear in the 'Program' window.

Finally, add the fourth test by double clicking the left mouse button, select 'TR Turns Ratio' from the 'Available Tests' window.

At the dialogue box, enter the data required for the turn's ratio test:

Voltage **1 V**
 Frequency **50 Hz**
 Integration (Leave as the default - **Medium**)

The AT measures the turns-ratio between 'primary' and 'secondary' windings; and allows the possibility of applying the test voltage to a third 'energized' winding. For this example, the primary and energized windings are the same:

- Energized high terminal **A**
- Energized low terminal **B**
- Primary high terminal **A**
- Primary low terminal **B**
- Secondary high terminal **C**
- Secondary low terminal **D**

Using the default '% 'type of limits, enter:

Primary: Secondary **1:1**
 Neg **2%**
 Pos **2%**

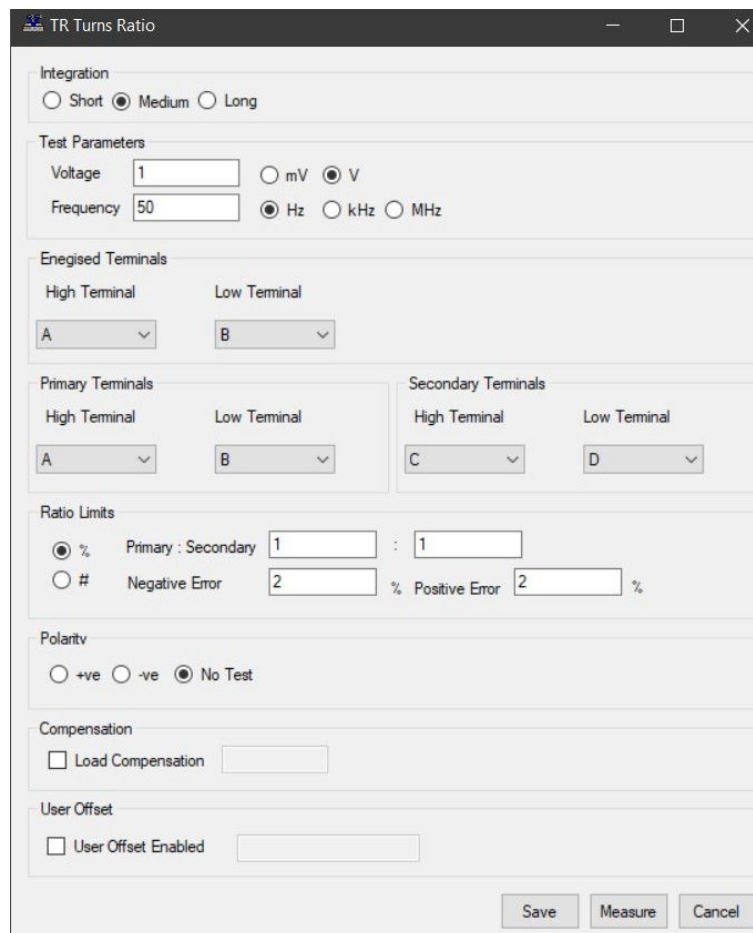

Click on the 'OK' button. Again, the test and its parameters will appear in the 'Program' window.

The lower left window should now contain the complete program. The scroll bars in this window enable you to view each test in the program in turn to check that it is correct.

3. Save the Program

The editor will not allow a program to be run in the AT unless it has previously been saved:

From the Top Level **'Part'** menu, select **'Save As,'**

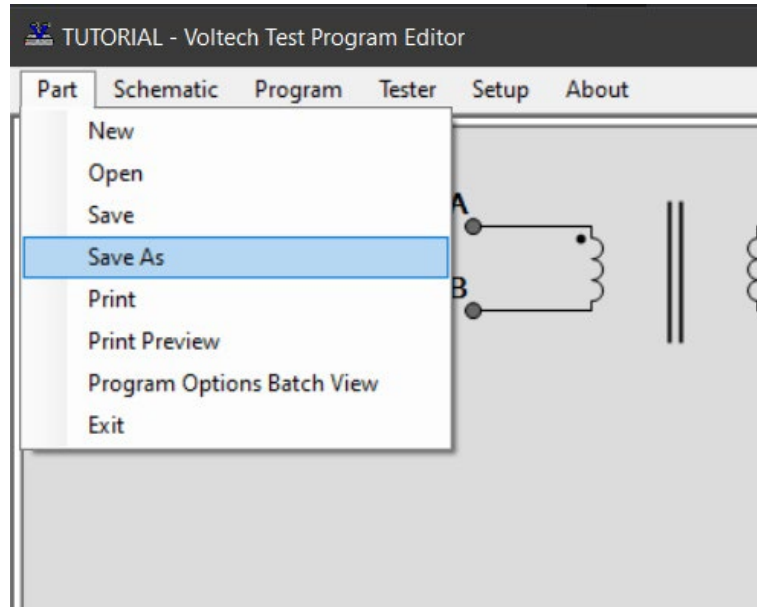

At the dialogue box, type in TUTORIAL as the part name. Click on the OK button to close the dialogue box and save the test program in a directory of your choice.

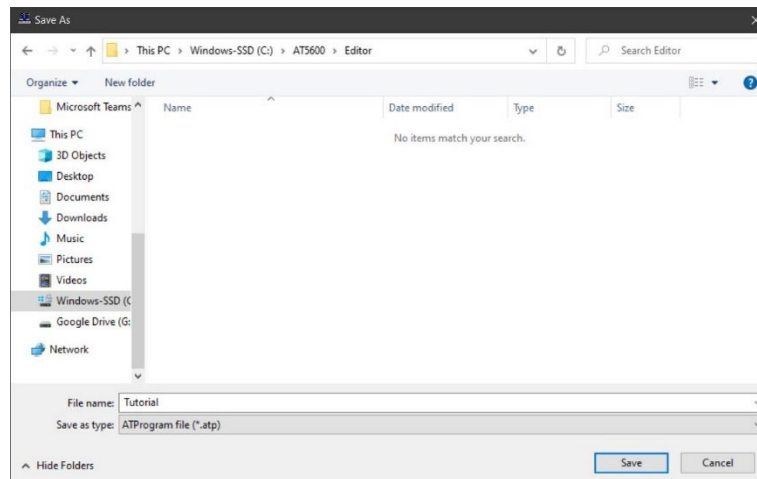

5.4.3. Running the Program from the Editor

Having created the test program, it is now ready to run on your AT5600 under the control of the Editor. Before proceeding further, make sure that the AT5600 has been powered on and communications are correctly configured in the editor (see 14.3.3).

To run the program:

1. From the Top Level '**Tester**' menu, select '**Download Program**'.

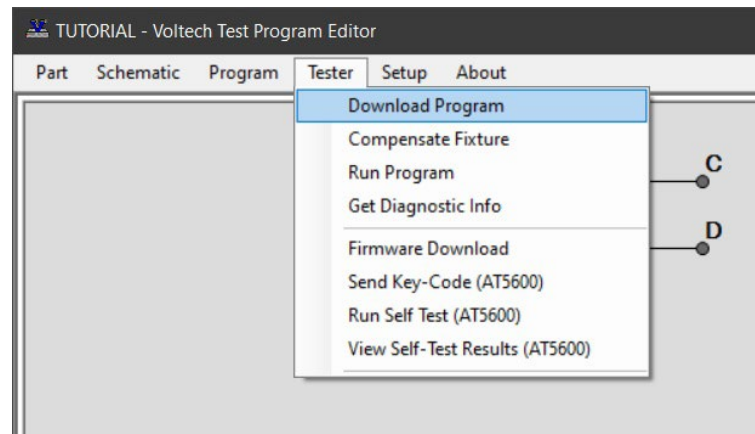

The editor will now download the test program to the AT5600. After a few seconds, you should see the message "The program download succeeded." Press OK to close the pop-up window.

If you see a message indicating that the download has failed, check your communications settings, and try again. If the download continues to fail, reboot your PC, and try again.

For now, run the program from the editor software.

2. Again, from the Top Level '**Tester**' menu, select '**Run Program**'.

The test program will now start running. When it is finished, you will see a dialogue box containing the results of the test.

If the transformer had been connected as in the schematic to nodes 7, 8, 9, and 10 then the results might be:

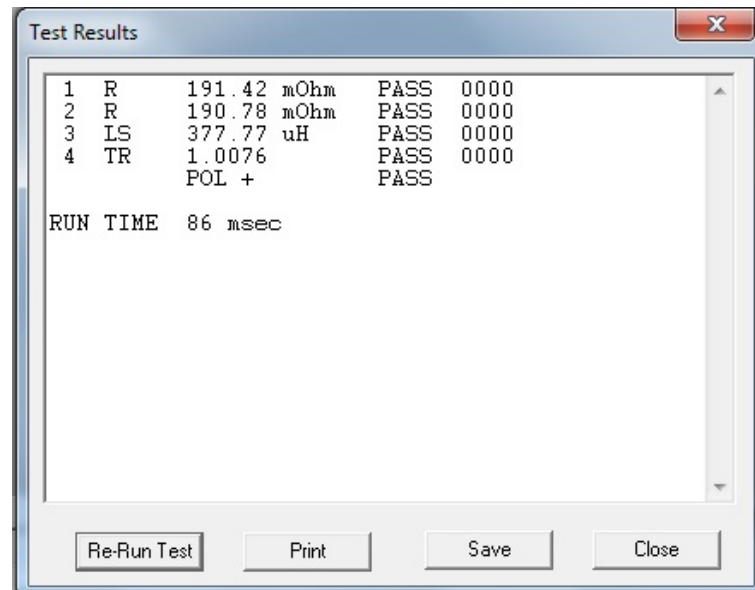

If there is no transformer is fitted, the results will have no meaning, but you have now successfully installed the AT5600 and the AT editor software.

The results window will give you the options to:

1. Re-run the test program.
2. Print the test results.
3. Save the test results.
4. Close the window.

Closing the window will return you to the top-level menu.

5.4.4. Transferring the Program to the Server

The Voltech Server software is supplied with every AT5600. The use of the Server software is required for handling and storage of test results and is recommended for handling large numbers of different test programs.

Having created, saved, and tested the program TUTORIAL using the Editor, you are now able to run it again on your AT Series Tester, but this time using the Server. The procedure for transferring the program to the Server archive will depend on where you have installed the Editor and Server programs.

Editor and Server on Separate PC's

In many situations, the Editor and Server would be installed on separate PC's (as shown in the illustration on page 2.2.2). It is not common for a company to use a Network drive to store test programs in one central location.

The *.ATP files can be easily moved using normal Windows Cut and Paste in windows explorer from your PC to a network drive.

Editor and Server on the same PC

If the Server and Editor are installed on the same PC, the easiest way to transfer the test program to the Server is to use the Save As menu in the Editor:

From the Top Level 'Part' menu, select 'Save As,'

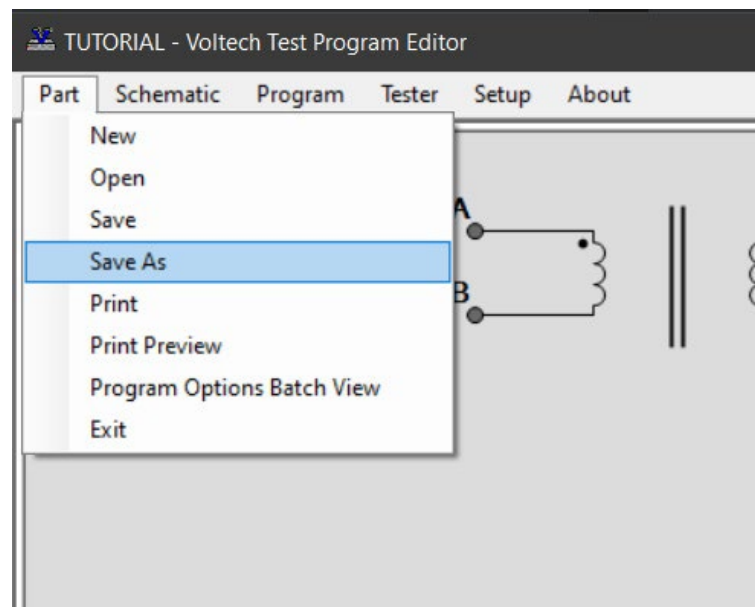

At the dialogue box, type in the part name **TUTORIAL**, as before, but change the directory to the one selected for program storage for the Server.

e.g., C:\AT3600\SERVER

Click on the **OK** button to close the dialogue box and save the test program in the Server program directory. (Note- the At Server allows you to change the program store directory, so check where the AT SERVER has the programs folder specified. This example shown is just the default directory.

Running a PROGRAM from AT SERVER

The next section of the Tutorial demonstrates running the program on the AT5600 tester from the Server store.

Before proceeding to that section, if the Server and Editor are using the same COM-Port on the single PC, re-allocate the COM-Port from the Editor to the Server:

1. Close the Editor by clicking on '**Part**' menu, select '**Exit** from the Top Level.
 2. Start the Server by double clicking on its Windows icon.
 3. Configure the COM-Port for the Server.
 4. Remove the cable between the AT Auxiliary Port and the PC COM-Port.
 5. Connect the cable between the AT Server Port and the PC COM-Port.
1. Start the Server program by double-clicking with the left mouse button on the Server icon.

Ensure the communication port is set up by clicking on '**Setup** menu, select '**Communications** from the Top Level. The configure server communication dialog box will now appear.



Add the Com Port assign to the server port to the open channel window, and then click Close.

2. Loading a program from the server:

A full description of the Front Panel operation is given in Chapter 8.

Using the front panel of the AT5600, from the top-level menu, tap the soft key EXECUTE to change to the following display:

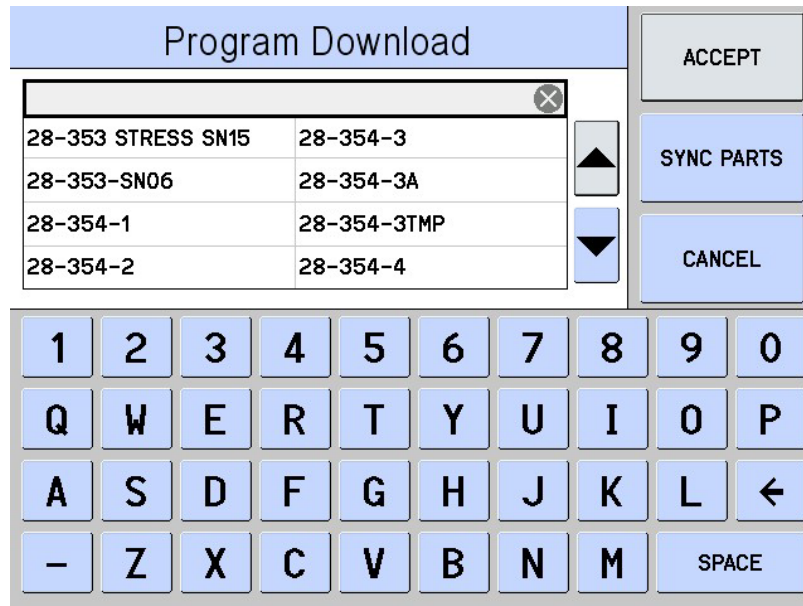

Select the program from the list or tap the data entry box on the main screen.

Enter the Part Number or the program name **TUTORIAL** in our example.

3. Run the Test:

Connect the transformer to the fixture and press the Run button. When the tester has finished testing, the result shall be displayed as shown.

Program Execution

Part Number: TUTORIAL
 Fixture: UNIVERSAL
 Serial: 100
 Next Serial: 101
 Batch: JUNE 2018
 Operator: ME

The part has passed. Please fit the next component to test then press RUN to execute the program.

Transformers tested:
 Total: 1
 Failed: 0 (0.0%)

Test Status: Passed

RESULTS

COMPENSATION

SN/BATCH/OP

FINISH

9 13

4. Viewing the Results:

To view the test results, tap the RESULTS soft key; you will see the following display:

Results

Id	Type	Minimum	Maximum	Result	P/F	Error
1	R	30.60 Ω	37.40 Ω	37.30 Ω	P	0000
2	R	30.60 Ω	37.40 Ω	36.75 Ω	P	0000
3	R	-----	800.0mΩ	717.8mΩ	P	0000
4	R	-----	800.0mΩ	691.4mΩ	P	0000
5	VOC	13.30 V	14.70 V	14.04 V	P	0000
			POL+	POL+	P	
6	VOC	13.30 V	14.70 V	14.04 V	P	0000
			POL+	POL+	P	
7	VOC	109.3 V	120.7 V	114.9 V	P	0000
			POL+	POL+	P	
8	MAGI	-----	10.00mA	3.996mA	P	0000
9	IR	50.00MΩ	-----	2.411GΩ	P	0000
10	HPAC	-----	5.000mA	794.4uA	P	0000

19:58

5.5. USB Printer Setup

The AT5600 can be configured to automatically print the test results at the end of each program run and the results.

Automatic printing is configured as part of the test program using the Editor software.

The Epson TM-T88V printer must be set to USB Printer Class mode to work properly with the AT5600.

Detailed Instructions for setting up the Epson TM-T88V printer for use with AT5600 is described in the following step-by-step instruction.

1. Close the paper roll cover of the Epson printer.
2. Turn on the printer while pressing the Feed button. The status shall print.
3. After the printing, has been completed, the Paper LED shall be flashing indicating that it is in set-up mode.

4. Press and hold the Feed button for more than one second. The printer shall enter the Mode Selection mode. The printer shall print the following.

Mode Selection

Modes

- 0: Exit and Reboot Printer
- 1: NV Graphics Information
- 2: Receipt Enhancement Information
- 3: Customize Value Settings
- 4 or more: None

Select Modes by executing following procedure.

- step 1. Press the Feed button less than 1 second as many times as the selected mode number.
- step 2. Press Feed button for 1 second or more.

5. Press the Feed button, for less than one second, three times. This will access *Mode 3. Customize Value Settings*. Then press and hold the Feed button for more than one second. The printer shall print the following.

Customize Value Settings

Modes

- 0: Exit
- 1: Print Current Setting
- 2: Print Density
- 3: Baud Rate
- 4: Automatic Paper Reduction
- 5: Auto Paper Feed & Cut at Cover Close
- 6: Paper Width
- 8: Default Character
- 9: Embedded Font Replacement
- 10: Interface Selection
- 11: USB Interface Settings
- 12: Power Supply Output
- 13: Printing Speed
- 14: Other Settings

Select Modes by executing following procedure.

- step 1. Press the Feed button less than 1 second as many times as the selected mode number.
- step 2. Press Feed button for 1 second or more.

6. Press the Feed button, for less than one second, eleven times. This will access *Mode 11. USB Interface Settings*. Then press and hold the Feed button for more than one second. The printer shall print the following.

```

11. USB Interface Settings

Modes
  0: Return to the previous menu
  1: Class
    
```

7. Press the Feed button, for less than one second, one time. This will access *Mode 11.1. Class*. Then press and hold the Feed button for more than one second. The printer shall print the following.

```

11. USB Interface Settings
  11.1. Class

Modes
  0: Return to the previous menu
] 1: Vendor Class
* 2: Printer Class

] means default value
* means current set value
    
```

8. Press the Feed button, for less than one second, two times. This will set the printer-to-Printer *Class*. Then press and hold the Feed button for more than one second. The printer shall print the following.

```

11. USB Interface Settings
  11.1. Class
    Printer Class

Saved. You can turn off the Printer
    
```

9. At this point, the changes to the setting have been saved and you can turn off the printer. The print is now ready for use.
10. Plug the printer into the Front or Rear USB 'A' port on the AT5600. If the printer is configured correctly, the system will display the Printer icon on the front panel as shown below.

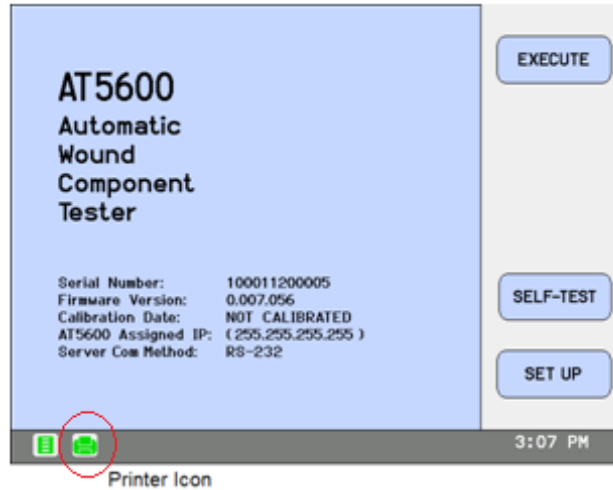

5.6. BARCODE Reader Setup

The AT5600 now supports USB barcode readers.

This simplifies the process of recording AT test results to a specific serialized transformer, giving you maximum traceability of results.

The barcode reader be used to enter any of the following input data, usually entered by the touch screen.

Program Name

Operator Name

Batch Number

Serial number (initial serial and after every test run)

The touch screen will still allow you to enter any of the above in the normal manual way if you wish.

The barcode reader simply connects to the USB-A port on the AT5600 (front or rear) and requires no extra power supply.

Please remember that the recording of Batch, Operator and Serial number are options in each test program (*.ATP) so must be enabled first per program before these can be recorded as part of the test results.

Which Barcode readers are supported?

Voltech recommends the [Honeywell Hyperion 1300G Barcode reader](https://www.honeywellaidc.com/en-GB/products/barcode-scanners/general-duty/hyperion-1300g).

<https://www.honeywellaidc.com/en-GB/products/barcode-scanners/general-duty/hyperion-1300g>

Whilst other HID barcode readers may function, due to subtle differences between different manufacturers, we cannot guarantee full compatibility.

Barcode Reader Set Up

Plug the USB barcode reader into the USB-A port.

This can be either on the front or rear of the AT5600.

On initial connection, the AT5600 will detect the 1300G and display a barcode on the display screen.

This is then scanned by the user to re-configure the barcode reader to optimum settings.

This is the same as programming the reader to **USB HID POS** settings as per the Honeywell user manual.

HID Keyboard

As our implementation on the communications uses the standard HDI (Human Interface Device) protocol, the new firmware also enables the use of a HID compliant USB keyboard.

Even if you do not wish to use a barcode reader, you can still use a HID USB keyboard.

Most modern desktop PC keyboards will support this.

Once plugged in, as with a barcode reader, text entry can be via the USB keyboard or touch screen.

Valid Characters for Serial / Operator / Batch

The USB barcode or USB keyboard input can only recognise the same characters as those that could be entered by the manual front panel keyboard method.

These are

- 0-9 Numerals
- A-Z Uppercase Characters ONLY
- "_" Minus symbol
- " " Space

Pease see updated sections of the manual.

8.1.14 Status bar icons

8.1.6.2+3+4+6 Description of the input screen where BARCODE reader can be used

6. Safety Systems

6.1. Introduction

Many of the tests available for the AT5600 can generate dangerously high voltages, which could cause operator injury unless proper safety precautions are taken.

The rear panels of the AT5600 and some AT accessories have been designed with a safety interlock connector, which is described in the user manual of those products.

Unless the three safety interlock signals on this connector are in the 'safe' condition, the tester will not run any tests.

The details of any safety system installation could vary depending on where the tester is being used. In a robotic production line, for example, the tester could be in an enclosed area, and the safety switches could be mounted in the door.

With manual production, the safety system could be based on a physical barrier, for example, a 'lid' fitted with safety interlock switches. However, the requirement to open and close such a barrier will give a slower speed of test, and often the reduced production throughput that follows from this may not be acceptable.

6.2. Recommended Safety Systems

The AT5600 which can generate dangerous voltages during routine production testing.

For optimum safety, ease of use, and test speed, Voltech recommends the use of a safety light curtain with the AT5600.

The safety system is based on the use of an infrared light curtain as a barrier between the operator and the dangerously high voltages present on the transformer under test.

The light curtain is positioned in front of the AT5600, the light curtain barrier extends well beyond the width of the tester so that the operator is not impeded when he/she must load and unload the transformer under test.

6.2.1. Description of the Banner Light Curtain system

An alternative Safety Light Curtain solution may be purchased direct from Banner Engineering.

This requires the simple addition of a Voltech Supplied cable (250-030) to the off-the-shelf Banner solution.

This solution is NOT CE-Marked, so will not be suitable for some countries.

Details of Banner OEM parts and installation are found in the manual.

98-121 Safety Interlock Cable for Banner EZAC-R9-QE8 User Manual

6.2.2. Constructing your own Safety System

Figure 6.2.3 shows the principles of how to construct a safety system based on the signals available on the 9-way AT Safety Interlock connector.

For the interlock to be activated three separate conditions must be met. One of the conditions is a fixed resistor which prevents accidental activation if all pins on the AT5600 are shorted together.

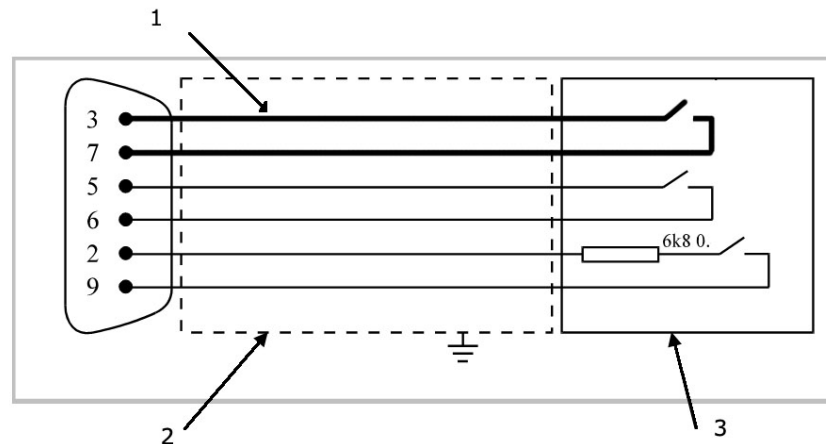

Notes:

- 1) The connection between pins 3 and 7 must be made with cable rated at 400V / 1A RMS or higher.
- 2) The Safety signal cables, and Safety relay must be protected from damage inside a covering which is earth bonded.
- 3) The safety signals may be switched using Safety electromechanical relays, contactors, or any other switches operated by a device that detects an operator has breached the safety barrier(s).

Voltech can supply a pre-made cable suitable for integrating the AT with your own system.

Part number 250-030

Safety Interlock Cable

User manual 98-121

Safety Interlock Cable User Manual

6.3. Safety Notices

Operator Safety

It is the responsibility of the user to ensure that the AT5600 and its associated safety systems are installed, maintained, and operated in accordance with all safety guidance and legislation that may be locally in force.

A light curtain will provide only part of the complete safety function that is required.

The AT5600 and light curtain must be installed by a designated Qualified Safety Person who will conduct an overall assessment of the risks involved and provide operator training, safety notices, and further safety equipment as well as install the AT5600 and light curtain in accordance with local regulations.

6.4. A Typical Installation of a Safety System

Any safety system should be thought of providing a total 'safety enclosure' which prevents access from all sides to the dangerous voltages on the transformer under test. The infrared safety system can only provide one side of this safety enclosure - that which faces the operator.

If there is a danger that an operator or any other person could touch the transformer under test from either the side or the rear of the tester, then you must also take steps to prevent this, by installing suitable physical barriers, if there is any danger that the operator could touch the transformer under test from above, then further precautions should be taken to provide physical barriers to guard against this.

Typical installation is shown below.

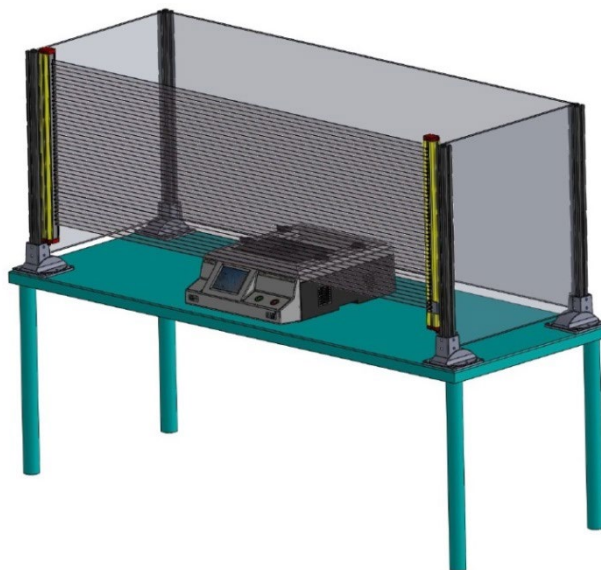

The infrared safety system is housed in three separate modules:

- 1 A vertical column of transmitters, which form the left-hand edge of the light curtain.
- 2 A vertical column of receivers, which form the right-hand edge of the light curtain.
- 3 A control box, containing the power supply circuits, the switching electronics and the interface to the tester.

The interconnection between each of the modules is via simple multi-way cables, which are easy for you to install.

Typical installation is shown below.

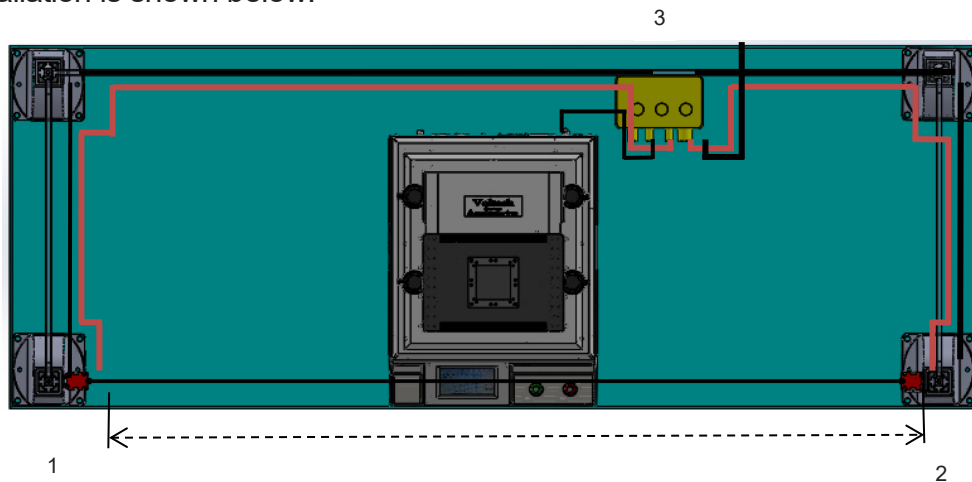

6.5. The AT5600 safety system user interface

This section describes the various operating and warning messages that may be observed on the AT5600 when it is being used with a safety light curtain.

Please consult the documentation supplied with your safety system for its own operating instructions.

The tester has three distinct points in its operation when it may check the condition of the safety interlock. Checks are made both before and during:

- Running test during program execution
- Performing the fixture compensation test within a program
- During Self-test.

If the safety system indicates that the light curtain is broken before the start of the measurement then the tester will display a Red Safety Interlock icon, otherwise the tester will display a Green Safety Interlock icon indicating the system is safe to use as shown below.

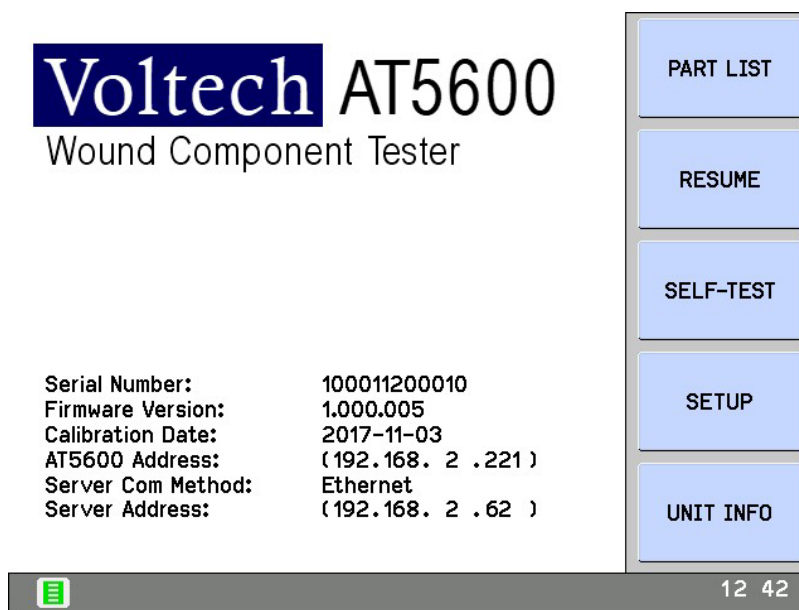

If the light curtain is beams are broken after the measurement has started, then the test will be stopped, and the voltage source shut down and the Safety Interlock icon shall change from Green to Red.

6.6. Constructing Safe Fixtures

When constructing a test fixture, the external surfaces of the transformer and its connections, must **NOT** protrude beyond any of the edges of the test fixture at any time.

This is to ensure that a safe working distance of 100mm minimum, is maintained from the transformer under test to the Safety Light Curtain Beam, which is protecting the operator(s) from the dangers of electric shock.

This ensures that the safety system has had time to de-energize the component under test before the user's hand has reached the component or its connections.

6.7. DC1000 DC Bias Current Source

When operating the DC1000A(s) with the AT5600, For Safety Requirements refer to DC1000A User Manual (98-102).

6.8. AC Interface Fixture

When operating the AC Interface Fixture with the AT5600,

For Safety Requirements refer to AC Interface Fixture User Manual (98-072).

7. Tests and Test Conditions

7.1. Available Tests

The following table summarizes the tests available for the AT5600 and indicates where they might be used.

To determine which test are available, connect the AT5600 to a PC via AUX port or USB-B port, launch the AT Editor. Tests which are not available for use shall be greyed-out in the Available Tests window.

If you have purchases an AT5600 Standard, you will find you only have 14 of the tests installed. Please contact Voltech if you wish to purchase tests that are not available. We can also issue a 30-day timed trial code free of charge to allow you try tests before committing to purchase.

See section 14.9 Customize Tester for instruction to upgrade your AT5600 with additional tests.

7.1.1. Low Voltage Tests

Test	Description	Main Application	Winding Tested	Reason for Test
CTY	Continuity	All transformers		Properly installed fixture
R	DC Resistance	All transformers	All windings	Properly installed fixture. Correct wire used. Integrity of terminations
LS	Inductance (Series circuit)	Most transformers but usually not line frequency transformers	One winding usually the primary	Correct primary turns. Right grade of core material. Core correctly assembled
LP	Inductance (Parallel circuit)	Most transformers but usually not line frequency transformers	One winding usually the primary	Correct primary turns. Right grade of core material. Core correctly assembled
QL	Quality Factor	Most transformers but usually not line frequency transformers	One winding usually the primary	Right grade of core material Core correctly assembled Check for shorted turns
RLS	Equivalent Series Resistance	Most transformers but usually not line frequency transformers	One winding usually the primary	Right grade of core material Core correctly assembled Check for shorted turns
RLP	Equivalent Parallel Resistance	Most transformers but usually not line frequency transformers	One winding usually the primary	Right grade of core material Core correctly assembled Check for shorted turns
D	Dissipation Factor	Most transformers but usually not line frequency transformers	One winding usually the primary	Right grade of core material Core correctly assembled Check for shorted turns
LL	Leakage Inductance	SMPS transformers Communication Transformers Others as applicable	Selected windings	Check windings have been installed in the correct position relative to the core
C	Interwinding Capacitance	High frequency transformers. Isolating transformers		Check winding positioning Check insulation thickness between windings
TR	Turns Ratio and Phasing	Most transformers, but usually not line frequency transformers	All windings	Check windings have corrected turns and phasing
TRL	Turns Ratio by Inductance	As with Turns Ratio but used where there is poor flux linkage between windings.	All windings	Check windings have correct turns and phasing

CHAPTER 7 - TESTS AND TEST CONDITIONS

LVOC	Low Voltage Open Circuit	All transformers	All other windings	Correct secondary turns. Correct phasing
LSB	Inductance with Bias Current (Series Circuit)	Transformers for use in applications where passing significant (DC) bias current is part of the normal operation	One winding	Correct number of turns. Right grade of core material Core correctly assembled
LPB	Inductance with Bias Current (Parallel Circuit)	Transformers for use in applications where passing significant (DC) bias current is part of the normal operation	One winding	Correct number of turns. Right grade of core material Core correctly assembled
R2	DC Resistance Match	SMPS, audio & telecom	All windings	Checks matching between windings
L2	Inductance Match	SMPS, audio & telecom transformers	All windings	Checks matching between windings
C2	Capacitance Match	SMPS, audio & telecom transformers	All Windings	Checks correct winding position on bobbin
GBAL	General Longitudinal Balance	Audio & telecom transformers	Selected Windings	Checks common mode rejection ratio
LBAL	Longitudinal Balance	Audio & telecom transformers	Selected Windings	Checks common mode rejection ratio
ILOS	Insertion Loss	Audio & telecom transformers	Selected Windings	Checks losses within the transformer
RESP	Frequency Response	Audio & telecom transformers	Selected Windings	Checks losses over a range of frequencies
RLOS	Return Loss	Audio & telecom transformers	Selected Windings	Checks losses returned by a transformer
Z	Impedance	Audio & telecom transformers	Selected Windings	Checks impedance at a given frequency
ZB	Impedance + bias	Audio & telecom transformers	Selected Windings	Checks impedance at a given frequency
ANGL	Impedance Phase Angle	Audio & telecom transformers	Selected Windings	Finds phase shift between Voltage and Current on a winding.
PHAS	Interwinding Phase Test	Audio & telecom transformers	Selected Windings	Measures phase shift between a pair of windings

7.1.2. High Voltage Tests

Test	Description	Main Application	Winding Tested	Reason for Test
HPDC	Hi-Pot (DC)	All transformers especially those used for safety insulation	Between selected windings usually primary to secondary, screens and core	High voltage safety insulation
HPAC	Hi-Pot (AC)	All transformers especially those used for safety insulation	Between selected windings usually primary to secondary, screens and core	High voltage safety insulation
SURG	Surge Stress Test	All transformers, especially those using fine wire	Selected windings	To identify shorted turns
IR	Insulation Resistance	All transformers	Between selected windings	Winding isolation check where safety is not involved
ILK	Leakage Current Test	Medical applications	Between Primary and Secondary Windings	Checks for a common mode current due to capacitance
MAGI	Magnetizing Current	Usually, line frequency transformers	One winding, usually the primary	Correct primary turns. Correct core material properly assembled
VOC	Open Circuit Voltage	Usually, line frequency transformers	All other windings	Correct secondary turns. Correct phasing
WATT	Wattage	50/60Hz Iron core transformers	One winding	Correct core material. Properly assembled
PWRF	Power Factor	Usually, line frequency transformers or Current Transformers	One winding, usually the primary	Power losses over whole transformer.
STRW	Stress Wattage	Line frequency & High Frequency Transformers	One Winding (Usually the primary)	Checks inter-turn insulation, magnetic material, and joints

7.1.3. DC1000 + DC1000A Tests

Test	Description	Main Application	Winding Tested	Reason for Test
LSBX*	Inductance with External Bias (Series Circuit)	Wound components that usually carry a significant DC Bias current in normal operation.	Selected Windings	Checks number of turns, right grade of correctly assembled core material, where bias current is greater than LSB test can manage.
LPBX*	Inductance with External Bias (Parallel Circuit)	Wound components that usually carry a significant DC Bias current in normal operation.	Select Windings	Checks number of turns, right grade of correctly assembled core material, where bias current is greater than LPB test can manage.
ZBX*	Impedance with External Bias	Audio & Telecom	Selected Windings	Checks impedance at a given frequency, while applying a greater bias current than is possible with ZB test.

These tests require the use of one or more Voltech **DC1000** Precision DC Bias Current Sources. Contact your Voltech sales office for details.

7.1.4. AC Interface Tests

Test	Description	Main Application	Winding Tested	Reason for Test
MAGX	MAGI (External Source)	Usually, line frequency transformers	One winding, usually the primary	Correct primary turns. Correct core material properly assembled
VOCX	VOCX (External Source)	Usually, line frequency transformers	All other windings	Correct secondary turns. Correct phasing
WATX	WATT (External Source)	50/60Hz Iron core transformers	One winding	Correct core material. Properly assembled
STRX	STRW (External Source)	Line frequency & High Frequency Transformers	One Winding (Usually the primary)	Checks integrity of inter-turn insulation, the magnetic material, and joints

These tests require the use of Voltech **AC INTERFACE FIXTURE**. Contact your Voltech sales office for details.

7.1.5. Other Functionality Options

Test	Description	Main Application	Winding Tested	Reason for Test
OUT	Output to User Port	Switching relays using the 6-way USER OUT port.	n/a	Allows the AT to perform external switching as part of the test program.
WAIT	Wait test	Introduce fixed duration or indefinite pause in program.	n/a	Allows time for core demagnetisation or for user to manually fit load resistors or change wiring etc

7.2. Self-Resonant Frequency

Practical inductive components are not perfect inductors; they have stray resistances and capacitances associated with them.

For certain components, especially those with a low inductance value, the impedance of the stray capacitance can become significant when compared to that of the inductance.

$$X_L = 2\pi fL \text{ (Inductive Impedance)}$$

$$X_C = \frac{1}{2\pi fC} \text{ (Capacitive Impedance)}$$

At a sufficiently high frequency, the capacitive impedance can dominate, making a measurement of the inductance impossible.

Under these circumstances, any measurement instrument may report negative inductance values and measurement errors.

Should these symptoms be observed, reduce the test frequency to avoid problems.

The frequency at which the inductive impedance equals the capacitive impedance ($X_L = X_C$) is known as the self-resonant frequency (SRF) of the component.

At this point, the phase angle of the impedance (which can be measured using the ANGL test) is zero.

At test conditions where the frequency is low enough for problems with capacitive impedance to be negligible, the phase angle will be positive and close to 90 degrees. Therefore, an ANGL test can be used during program development to confirm if measurement problems are due to the chosen test frequency approaching the SRF of the part under test.

If the angle is significantly less than 90 degrees, consider reducing the test frequency.

Note that stray fixture capacitance will add to the capacitance of the component and reduce the SRF.

Performing compensation will remove the effect of stray fixture capacitance on the measurement of capacitance but cannot remove its effect on SRF.

7.3. Explanation of Integration

Integration is used during the Test Execution measurement process. The AT5600 allows a choice of three types of measurement Integration, Short, Medium, and Long. The Integration type is selected when the Test Program is created using the Editor Software.

Each measurement result from the AT5600 is derived by making a sequence of consecutive sub-measurements and computing the mean of these sub-measurements. For example, a resistance test of the 10 sub-measurements below would report a mean value of 10.0 ohms: -

10.20	9.90	9.90	9.93	9.80	9.85	10.10	9.98	10.10	9.91
-------	------	------	------	------	------	-------	------	-------	------

The key decision that the AT5600 must make is how many sub-measurements to take to produce a result. This is done by using the mathematics of statistical analysis.

The variation in the values of sub-measurements follows what is termed a "normal distribution" in statistical analysis:

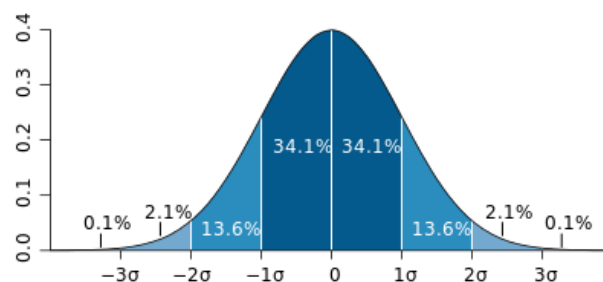

A plot of a *normal distribution* (or bell-shaped curve) where each band has a width of one standard deviation.

As each sample is collected the AT5600 computes the **standard error of the mean** (https://en.wikipedia.org/wiki/Standard_error):

$$SE_{\bar{x}} = \frac{s}{\sqrt{n}}$$

Where:

s is the **sample standard deviation** (i.e., the sample-based estimate of the standard deviation of the population), and

n is the size (number of observations) of the sample.

This value is used to compute the **relative standard error** which is the standard error divided by the mean and expressed as a percentage.

https://en.wikipedia.org/wiki/Standard_error#Relative_standard_error

The larger the number of sub-measurements (n) the smaller will be the relative standard error, but the greater the time to get a result. The AT5600 provides for three levels of integration Short, Medium, and Long. The following table shows the relative standard error corresponding to each integration level:

Integration Level	Relative standard error
Short	1%
Medium	0.3%
Long	0.03%

As a guide to which integration level to set, consider the tolerance that is being set for each measurement.

For example, consider the R test for a winding of 11.3 ohms nominal, which has an expected value of 10.8 ohms, and the upper limit of the test set to 12 ohms.

The uncertainty that the measurement must be made to must be less than

$$100 * (12 - 11.3) / 11.3 = 6.2\%.$$

For margin, the integration level should be chosen for a relative standard error of no more than half of the uncertainty-in this case short integration should be chosen as its relative standard error is much less than half of the uncertainty required.

On the other hand, consider measurement of the Q factor of an inductor with an actual Q of 110: -

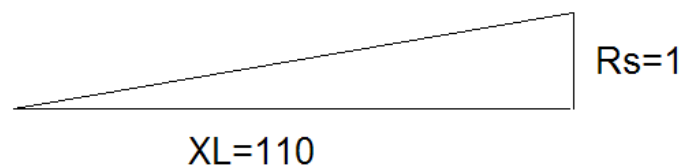

The value of Rs represents $1 / 110 = 0.909\%$ of the impedance of the inductor.

If the minimum Q that is acceptable is 100, then Rs must be measured to better than $100 * (110 - 100) / 100 = 10\%$ of its nominal value; the uncertainty of the measurement must be less than $0.909\% * 10\% = 0.0909\%$. In this case, long integration should be chosen.

For production testing, test limits are usually sufficiently wide to allow short (and occasionally medium) integration to be chosen, and this will result in the shortest possible test times.

7.4. CTY - Continuity

Where Used

The continuity test is available to be placed as the first test in the program to check that the transformer has been inserted correctly into the test fixture. The test checks that every winding has a resistance less than a user specified limit, with the same limit being applied to all windings.

The CTY test is an alternative to using an R (Winding Resistance) test on each winding separately. The CTY test has the advantage of speed of execution for the AT3600; but with the R test, individual limits can be applied to each winding, and manufacturing faults such as the use of the wrong wire gauge can be identified. CTY maintains compatibility with the AT5600, but with no speed advantage as the AT5600 is much faster than the AT3600, therefore an R Test is recommended rather than the CTY Test.

If you choose to use it, the continuity test will be quicker to execute than a series of resistance tests applied to each winding.

Specifying the Test Limit

When specifying the test limit, remember that the same limit is applied to each winding, so you must choose a value higher than the resistance of the biggest winding. For most transformers, where the winding resistances are less than 1k Ω , a test limit of 10k Ω should be used, as this will give the quickest test execution.

Please also see

AT dotNET Editor manual (98-125 Ch2.5) for specific advice on programming the test

and

10.2.1 for test accuracy specification

7.5. R - Winding Resistance

Where Used

The measurement of the resistance of all windings should be the first group of tests carried out for any type of transformer. It checks that the wire is of the correct diameter and has not been over-tensioned during winding.

The measurement also confirms that the connections between the test fixture and the transformer have been made properly. This is particularly important when Kelvin connections are required, as a resistance measurement will confirm that both the power lead and sense lead are making good electrical contact.

The R test can also be used in conjunction with the STOP ON FAIL editor program option if you wish to save time by not testing the remainder of the program when a part fails a simple initial resistance test.
(See dot NET AT Editor user manual 2.4.1.8 for more details)

To check if the resistance of a winding is correct, the tester applies a constant current (DC) to the selected winding. Both the current through and the voltage across the winding are measured; dividing the voltage by the current gives the value of the resistance.

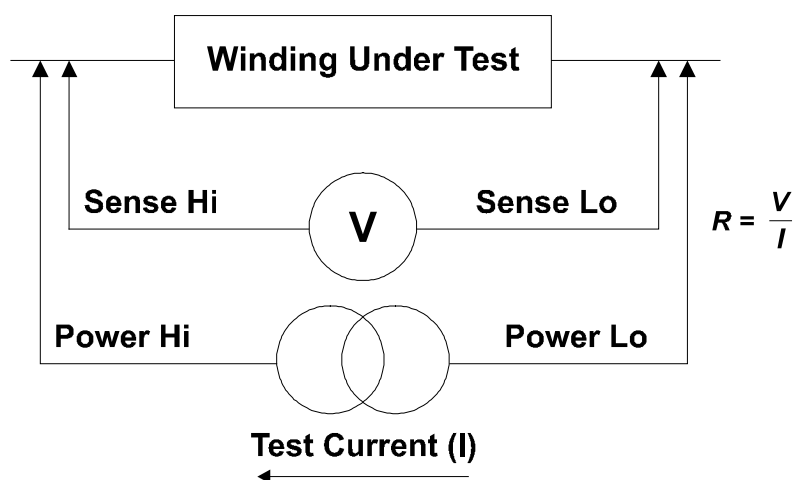

Specifying the Test Limits

Maximum Value - Specify limit as tightly as possible to ensure that correct wire has been used.

Minimum Value - Not usually so critical - can be set to any value that ensures that there is no solder splash causing a short circuit between pins.

Test Current

The test signal is set according to the value specified as maximum in the test limits: -

Maximum Resistance R	$<1\Omega$	$1\Omega-10k\Omega$	$10k\Omega-50k\Omega$	$>50k\Omega$
Test current	$I=1$	$I=1/R$	$V=R*100u$	$V=5$

Where:

V = Volts (V)

I = Current (A)

R = Resistance (Ω)

Please also see

AT dotNET Editor manual (98-125 2.5.4) for specific advice on programming the test

10.2.1 for test accuracy specification

7.6. RLS or RLP - Equivalent Series or Parallel Resistance

Where Used

The equivalent series or parallel resistance measurements are alternatives to a Q factor measurement to follow the inductance test in the program.

The RLS (or RLP) is a combination of the winding resistance and any losses due to the core (usually eddy currents and/or hysteresis loss effects). A classic DCR test will only tell you the winding resistance. Hence the RLS or RLP tests will help you detect inferior quality core material or bad laminations.

As with the Q factor measurement, an equivalent series or parallel resistance test would normally be used for signal, pulse, and switched mode power transformers, where the normal operating conditions require only small excursions of the B-H curve, never extending beyond the linear regions.

An equivalent resistance test is also one way of highlighting weak or shorted turns within the transformer.

Measurement Conditions

As with measuring inductance and Q factor, to measure an equivalent series or parallel resistance, the tester applies an AC voltage across the selected winding. It then measures the voltage across and current through the winding using harmonic analysis. The measured voltage is divided by the current to obtain the complex impedance and the equivalent series or parallel resistance calculated.

If, in the program, the RLS or RLP test follows either a LS or LP test which has the same test conditions (voltage and frequency), and is applied to the same winding, then the measurement results from the previous inductance test can be re-used, saving program execution time.

The test signal can have a frequency in the range 20Hz to 3MHz and amplitude from 1mV to 5V.

Normally when following an inductance test, you would choose the same test conditions for the RLS or RLP test. If the RLS or RLP test does not have an associated inductance test, then choose the test conditions as detailed in Section 7.7.2 , based on the value of the inductance of the winding under test.

Please also see

AT dotNET Editor manual (98-125 2.5.3) for specific advice on programming the test

10.2.2 for test accuracy specification

7.7. LS or LP - Inductance (Series or Parallel Circuit)

Where Used

The AT5600 offers two basic alternative ways to confirm that the transformer has been assembled properly, with the appropriate number of primary and secondary turns, the right grade of magnetic material for the core, and the correct air gap if required.

Any real inductor can be expressed as either an equivalent series RL circuit or a parallel RL circuit.

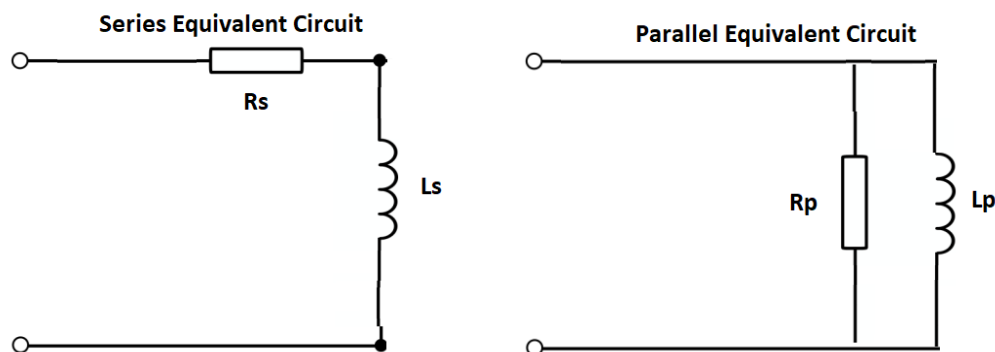

In an Ideal inductor $R_s=0$, $R_p=\text{infinity}$, hence $L_S=L_P$,

However, in real inductor, the inductance values for the two circuits are not necessarily the same. This should be born in mind when specifying the test limits.

Inductance is always measured as part of the complex impedance; the result being expressed in terms of either a series or parallel equivalent circuit by choosing either the LS or LP test.

When testing signal, pulse, and switched mode power transformers, where the normal operating conditions require only small excursions of the B-H curve, never extending beyond the linear regions, a measurement of primary inductance, together with a turns ratio test is used.

For line frequency transformers, designed to operate over the full extent of the B-H curve, including the non-linear regions, the preferred method is to use a magnetizing current test applied to a primary winding, followed by an open-circuit voltage test for every other winding.

Measurement Conditions

To measure inductance, the tester applies an AC voltage across the selected winding; it then measures the voltage across and the current through the winding using harmonic analysis. The measured voltage is divided by the current to obtain the complex impedance and the inductance is calculated.

The test signal can have a frequency in the range 20Hz to 3MHz, and amplitude from 1mV to 5V.

It is not necessary to measure the inductance at the normal operating conditions of the transformer, which could involve, for example, voltage levels of hundreds of volts. This is because the B-H curve can normally be assumed to be linear in the operating region, and the inductance measured at a low level represents the inductance that will appear in use.

Also, it can usually be assumed that the inductance value does not vary significantly with frequency. Therefore, although high frequencies are available with the tester, measurement frequencies above a few hundred kilohertz should be used with caution. This is because the errors caused by the stray inductance and capacitance of your fixture may become much more significant at these frequencies. Compensation can be used to eliminate these errors.

The following table suggests suitable test conditions for different values of expected primary inductance:

Inductance range			Preferred test signal	
			Frequency	Voltage
100nH	→	300nH	3 MHz	50 mV
300nH	→	1uH	1 MHz	150 mV
1uH	→	3uH	1 MHz	500 mV
3uH	→	10uH	300 KHz	500 mV
10uH	→	30uH	100 KHz	500 mV
30uH	→	100uH	30 KHz	500 mV
100uH	→	300uH	10 KHz	500 mV
300uH	→	1mH	3 KHz	500 mV
1mH	→	3mH	1 KHz	500 mV
3mH	→	10mH	300 Hz	500 mV
10mH	→	30mH	100 Hz	500 mV
30mH	→	100mH	50 Hz	1 V
100mH	→	300mH	50 Hz	3 V
300mH	→	1H	50 Hz	3 V
1H	→	3H	20 Hz	3 V
3H	→		20 Hz	5 V

The Test Conditions for Inductance Measurements

Wherever possible, this table should be used for all inductance tests. The inductance range should be chosen based on minimum value of inductance expected. When choosing the test conditions, the following potential problems should be considered:

Current levels

The upper voltage limits should be chosen to give a maximum current level of about 50mA RMS. for the lowest inductance expected. In some cases, this current may cause core saturation, and a lower voltage should be used. The minimum voltage level must be chosen so that the test current does not become so low that it cannot be sensibly measured. The lower voltage limits in the table above always give test currents higher than 3µA RMS.

Self-Resonant Frequency

At lower frequencies, the capacitance of the windings can normally be ignored because its impedance is much higher than that of the inductance. However, at extremely high frequencies, this is not so, the capacitance dominates, and inductance cannot be measured. The self-resonant frequency of the transformer is the change-over point between these two regions.

Normally to get a good measurement of inductance, the test frequency should be less than 20% of the resonant frequency of the transformer.

In general, high values of inductance will have a high inter-turn capacitance and hence a low resonant frequency. Where there is a choice of test frequencies always use the lower value, to minimize any problems due to self-resonance.

Non-linear inductance

Normally inductance measurements should be used for transformers where the B-H characteristics are linear.

However, if inductance measurements are attempted for instance with line frequency transformers where the core material is non-linear even at low signal levels, the measured results can be highly dependent on the applied test signal.

This can be a problem when trying to compare measurements made on commercially available impedance bridges, or component testers, with measurements made using the AT5600. The test signal in such bridges is usually determined within the instrument and is often at a fixed frequency and at a voltage level which is not guaranteed to be constant for all value of inductance.

Usually, if the actual test conditions of the bridge can be determined, and the tester is then programmed to deliver the same test conditions across the inductance the results will then agree. (See also the comments below on differences caused by the choice of equivalent circuit) .

Please also see

AT dotNET Editor manual (98-125 2.5.6) for specific advice on programming the test 10.2.2 for test accuracy specification

7.8. LSB or LPB-Inductance with Bias Current (Series or Parallel Circuit)

Where Used

With the LSB and LPB tests, the AT5600 offers two further ways to confirm that the transformer has been assembled properly, with the appropriate number of turns, the right grade of magnetic material for the core, and the correct air gap if required.

These tests would normally be used for transformers designed to be used in applications where a large DC current is flowing through one or more of the windings.

Measurement Conditions

To measure inductance with bias, the tester firstly applies the programmed bias current to the winding under test. When this has stabilized, it then applies an AC voltage across the selected winding and measures the voltage across and the current through the winding using harmonic analysis. The measured voltage is divided by the harmonic current to obtain the complex impedance and the inductance is calculated.

The bias current can be programmed in the range 10mA to 1000mA. The (AC) test signal can have a frequency between 20Hz and 3MHz, and amplitude from 1mV to 5V.

Usually, the signal frequency and voltage are chosen so that, with the expected inductance, the resulting signal current is less than 20% of the bias current.

Recommended test signals would be the same as given in Section 7.7.2 , for the normal inductance test. However, if the recommended levels correspond to too high a signal current, then use a corresponding smaller test voltage.

It is not normally recommended that the test frequency be increased to reduce the signal current, as this may lead to other problems, such as those caused by parasitic inductance and capacitance of the test fixture, and the self-resonant frequency of the transformer itself.

Please also see

AT dotNET Editor manual (98-125 2.5.7) for specific advice on programming the test

10.2.14 for test accuracy specification

7.9. QL - Quality Factor

Where Used

The Q (quality) factor measurement would normally follow a measurement of the inductance of the primary winding in the test program. It is proportional to L/R , so pure "ideal" inductors with minimal resistance will have a high Q.

Q is defined as Reactive Inductance divided by AC Resistance. ($2\pi f \times L / R$)

As with an inductance measurement, the Q factor test would normally be used for signal, pulse, and switched mode power transformers, where the normal operating conditions require only small excursions of the B-H curve, never extending beyond the linear regions. Pulse transformers need to be able to cope with the high frequency components of square waves, so knowing and checking the Q factor over frequencies is critical.

A Q factor test is also one way of highlighting shorted turns within the transformer. A shorted turn would induce a higher current, and the associated power losses ($I^2 \times R$) would be much higher. and hence a drop in quality of performance and hence drop in Q factor.

In the case of pulse or signal transformers, a traditional High Voltage SURGE testing is not a valid or desirable test, as the part is not designed for such high voltages, so Q can be used instead.

Measurement Conditions

To measure Q factor, the tester performs the same steps that would be used to measure inductance. The only difference is in the calculation at the end of the test: the measured voltage is divided by the current to obtain the complex impedance from which the Q factor is calculated.

The test signal can have a frequency in the range 20Hz to 3MHz, and amplitude from 1mV to 5V.

Normally when following an inductance test, you would choose the same test conditions for the QL test. If the QL test does not have an associated inductance test, then choose the test conditions as detailed in Section 7.7 based on the value of the inductance of the winding under test.

Please also see

AT dotNET Editor manual (98-125 2.5.8) for specific advice on programming the test 10.2.3 for test accuracy specification

7.10. D – Dissipation Factor

Measurement Range	Test Voltage	Test Frequency	Basic Accuracy
0.001 to 1000	1mV to 5v	20Hz to 3MHz	0.50%

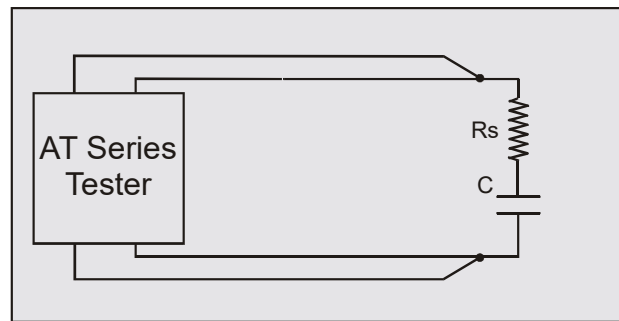

The parameter 'D' is most often used as a measurement of the losses in a capacitor. It is analogous to Q for a transformer winding.

For this equivalent circuit, the Dissipation Factor D is defined as:

$$D = \frac{R_s}{X_s} = \frac{R_s}{1/\omega C_s} \quad (\text{where } \omega = 2\pi f)$$

For a given capacitance, the lower the equivalent series resistance, the lower is the value of the dissipation factor or $\tan\delta$, i.e., the 'better' the capacitor. D is also just the inverse of Q (see above), for both capacitors and inductors, but it is common to talk of Q for inductors and D for capacitors.

Where used

The dissipation factor test would normally be used for capacitors of all types. A D factor test will help to determine that the capacitor has been manufactured correctly.

Measurement conditions

To measure Dissipation Factor, the tester applies an AC voltage across the selected winding and measures the voltage across and the current through the winding. Using harmonic analysis, the measured voltage is divided by the current to obtain a complex impedance from which the Dissipation Factor is obtained.

Choosing the test signal

For optimum accuracy and performance, use the test conditions chosen for capacitance in a later section of this chapter.

Please also see

AT dotNET Editor manual (98-125 2.5.9) for specific advice on programming the test

10.2.3 for test accuracy specification

7.11. LL - Leakage Inductance

Where Used

Leakage inductance is important in many applications. One example is fly-back designs for high frequency switched mode power supplies, where the leakage inductance must be less than a specified critical value for proper operation.

LL is commonly modelled as an extra inductor on the primary, which does not produce any useful transfer of power to the secondary – it is a loss hence the use of the term “leakage inductance”.

Designers typically will try to minimise LL, but there are applications where it may be desirable to design it in (for example microwave PSUs) . In both cases, measuring and controlling LL is essential.

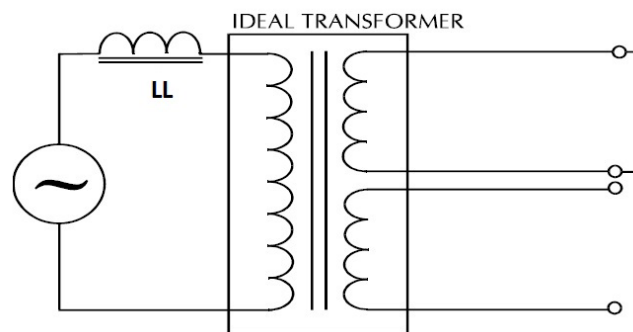

Measurement Conditions

Leakage inductance is tested by measuring the inductance of a 'primary' winding when one or more 'secondary' windings are shorted out. In performing the calculation at the end of the test to extract the inductance value from the measured winding impedance, the tester uses a series equivalent circuit.

In making the measurement, the tester automatically compensates for the impedance of the wiring, the connections, and the relays in the shorting path.

Leakage inductance can be measured using a test current in the range 20 μ A to 100mA at a frequency of 20Hz to 3MHz.

You may choose a suitable test current, and frequency based on the expected value of the leakage inductance using the following table:

Leakage Inductance range			Preferred test signal	
			Frequency	Current
100 nH	→	1 uH	300 kHz	50 mA
1 uH	→	10 uH	100 kHz	20 mA
10 uH	→	100 uH	30 kHz	10 mA
100 uH	→	1 mH	10 kHz	5 mA
1 mH	→	10 mH	1 kHz	5 mA
10 mH	→	100 mH	100 Hz	5 mA
100 mH	→	1 H	100 Hz	1 mA
1 H	→	10 H	50 Hz	500 µA

The Test Conditions for Leakage Inductance Measurement

NOTE: Because leakage inductance is measured with a secondary winding shorted out, be careful to choose a test signal that will not cause excessive currents to flow. This is particularly significant in transformers where the turns ratio is extremely high, and the shorted winding has only a few turns.

If, for example, the primary winding has 300 turns, and the secondary 3 turns, a test current of 10mA flowing through the leakage inductance on the primary side will give rise to a current of 1 Amp flowing in the shorted secondary winding.

To protect transformer windings, the test current when measuring leakage inductance is limited in the table to 50mA maximum.

In addition, the problem of self-resonant frequency listed under the primary inductance test also applies when measuring leakage inductance, so always use the lower of the available band of frequencies.

User Offset

This is used to offset the result returned by the AT by a user defined amount.

i.e., **Result returned = Measured result + User offset**

Normally a user offset would not be required. However, for small values of leakage inductance (<1µH) when there are many additional low terminals, it is not always possible during fixture compensation for the tester to remove all the parasitic errors of the test fixture. In this case, the user offset may be required to fully remove the errors and normalise the result to an LCR reading measured using a perfect short, which is not practical in production testing.

Please also see

AT dotNET Editor manual (98-125 2.5.10) for specific advice on programming the test

10.2.2 for test accuracy specification

7.12. C - Interwinding Capacitance

Where Used

Capacitance occurs in transformers due to the physical proximity of, and electrostatic coupling between, different turns of wire.

In general, the capacitance is distributed between the different layers within a winding, and between the outside layer of one winding and the inside layer of the next.

Although the capacitance is distributed across the whole winding, it is usually represented by a simple equivalent circuit showing a single capacitance from one winding to the next.

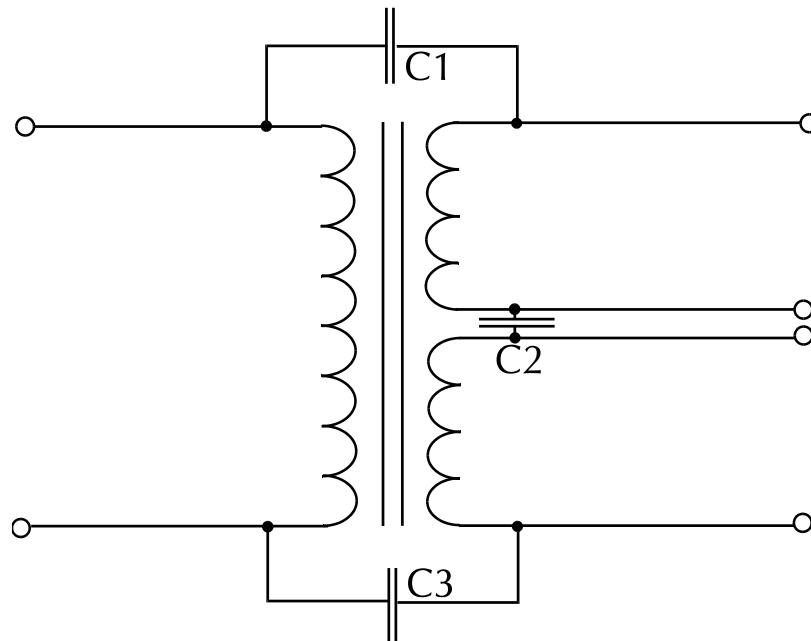

Inter-winding capacitance may be of interest in transformers used in audio, medical and instrumentation applications, where isolation between primary and secondary windings is important.

It can also play an important part in the circuit operation of switch-mode transformers where, for example, too large a capacitance may give rise to a large amount of noise at the switching frequency being coupled into sensitive circuits connected to the secondary windings.

For balancing of winding capacitances, where matching the capacitance on two or more windings is more important than the actual individual capacitance, please see the C2 test.

Measurement Conditions

To measure capacitance, the tester applies an AC voltage between the windings to be tested, usually with all taps on each winding shorted together. It then measures the voltage between the windings, and the resulting current using harmonic analysis. Dividing the voltage by the current gives the inter-winding impedance, from which the capacitance may be calculated.

The test voltage can be in the range of 1mV to 5V at a frequency of 20Hz to 3MHz.

The table below gives the recommended test conditions for different values of capacitance:

Capacitance range			Preferred test signal	
			Frequency	Voltage
1 pF	→	10 pF	100 KHz	5 V
10 pF	→	100 pF	100 KHz	5 V
100 pF	→	1 nF	10 KHz	5 V
1 nF	→	10 nF	1 KHz	5 V
10 nF	→	100 nF	100 Hz	5 V

The Test Conditions for Capacitance Measurement

When choosing the test conditions, the following potential problems should be considered:

Current levels

For larger capacitance, particularly at higher frequencies, the current flowing during the measurement can be extremely high, and similarly the measured current could also be exceedingly small for small capacitance at lower frequencies and voltages.

Where possible, you should use the recommended test signal levels in the table above to ensure that the currents which flow can be measured accurately.

Non-linear Capacitance

Normally non-linearity in the stray capacitance of transformers is not a problem, and therefore capacitance is measured with as large a voltage as possible.

Equivalent Circuit

As with inductance, capacitance is measured as a complex impedance, and therefore the result can be expressed in terms of either a series or a parallel equivalent circuit.

It was explained in section 7.7 of this chapter that parallel, and series equivalent inductance do not necessarily have the same values. The same is true for capacitance; parallel and series equivalents can also be different.

The AT testers always uses a parallel equivalent circuit for capacitance measurements.

Please also see

AT dotNET Editor manual (98-125 2.5.11) for specific advice on programming the test

10.2.2 for test accuracy specification

7.13. TR - Turns Ratio

Where Used

The AT5600 offer two basic alternative ways to confirm that the transformer has been assembled properly, with the appropriate number of primary and secondary turns – TR or VOC

Turns ratio is the preferred test for signal, pulse, and switched mode power transformers, where the normal operating conditions require only small excursions of the B-H curve, never extending beyond the linear regions.

The result of a TR test is simply the ratio of voltages measured on your chosen nodes. The energised winding can also be independent of primary or secondary if you so wish.

For line frequency transformers, designed to operate over the full extent of the B-H curve, including the non-linear regions, the preferred method is to use an open - circuit voltage VOC test to check for the correct numbers of turns on each winding.

Clearly a turns ratio test cannot tell you the actual number of turns on a winding, only the ratio between the primary and secondary. You should therefore ALSO have at least one inductance test in your program to give confidence that the absolute number of turns is correct as well as the ratio.

Measurement Conditions

To measure turns ratio, a test source voltage is applied to one winding, the energized winding, and the voltages across two other windings (one of which may also be the energized winding) are measured using harmonic analysis. The turns ratio is measured by dividing one measured voltage by the other and making a compensation for the effects of winding resistance.

It is recommended that you choose the winding with the highest number of turns as the one to be energized. An exception to this rule is when you wish to measure the ratio between two windings which should be accurately matched at 1:1. In this case it may be better to energize a third winding with a lower number of turns, to ensure that any measurement errors apply equally to the two windings under test.

You can specify the signal to be applied to the energized winding to have a frequency in the range 20Hz to 3MHz, and amplitude from 1mV to 5V.

The recommended test conditions depend on the inductance of the energized winding; they are given in the table in Section 7.7 LS,

Best performance assumes that the energized winding is the one with the highest number of turns.

V Applied and V measured

The signal is usually applied to the primary winding, or the winding which has the largest number of turns. However, if by doing this, the expected voltage on the winding with the smallest number of turns falls below 1mV, then the test voltage should be increased.

Best repeatable measurements will be obtained ONLY if the V Energized, V applied, and V measured are ALL > 1mV.

This may also require an increase in the test frequency so that the current taken by the driven winding does not become too large, but in general this frequency increase should be kept as small as possible to avoid problems caused by stray capacitance at high frequencies.

Where Matching in Groups is Important

In some transformer designs, the turns ratio between a primary winding and a secondary winding is not as important as the ratio between different primaries or different secondaries.

To make the most accurate measurements in such cases apply the test signal to the primary winding and measure the turns-ratio from primary to one of the secondaries.

Then, leaving the primary energized as above, measure the turns ratio between the secondaries.

Next, energize a secondary winding (possibly at a different voltage and / or frequency depending on its inductance) and measure the turns ratio between the various primaries.

In this way windings, which should be matched are treated equally during the test.

7.13.1. Best Practice for Centre Taps / Auto transformers

(Also Applies to tests TR, TRL, LVOC, VOC, VOCX)

When testing TR (or similar) on windings where the energized/primary are on the same coil as the secondary, it is important to minimize the effect of common mode signals to get the best measurement.

This can be achieved by programming the energized nodes so that the secondary winding is always at the LO end of the primary. As the AT EDITOR allows you to choose any node it is best to consider this when programming the test.

Please consider the following two examples which illustrate this point.

A Best Practice set up – USE this configuration.

All the LO terminals are defined as “A”
 The secondary is at the LO end of A-C ; SEC LO is at 0 V

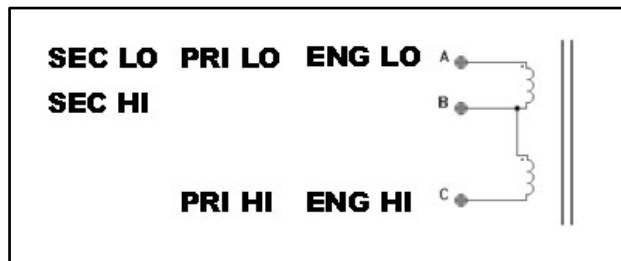

B, NON-OPTIMAL set up – AVOID this configuration.

The secondary is at the HI end of A-C; hence SEC LO is not at 0V, potentially causing a common mode effect.

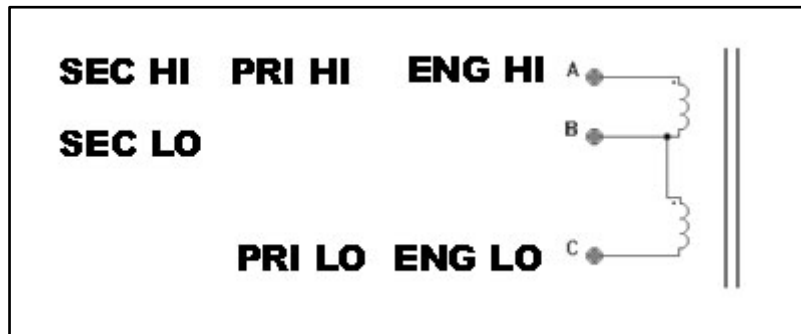

TR Turns Ratio

Integration
 Short Medium Long

Test Parameters
 Voltage mV V
 Frequency Hz kHz MHz

Enabled Terminals
 High Terminal: Low Terminal:

Primary Terminals
 High Terminal: Low Terminal:

Secondary Terminals
 High Terminal: Low Terminal:

Ratio Limits
 % Primary : Secondary :
 # Negative Error % Positive Error %

Polarity
 +ve -ve No Test

Compensation
 Load Compensation

User Offset
 User Offset Enabled

Save Measure Cancel

Specifying the Test Limits

When specifying turns ratio tests, it is preferable to avoid limits which are unnecessarily tight, and which may therefore lead to measurement difficulties.

For example, if two equal secondary windings should have 10 turns each, the ratio should be 1:1. One turn in error would produce a ratio error of 10% or -10% (i.e., 11:10 or 10:11), and therefore limits of +5% and -5% would be suitable to detect the error.

Please also see

AT dotNET Editor manual (98-125 2.5.12) for specific advice on programming the test

10.2.4 for test accuracy specification

7.14. TRL - Turns Ratio by Inductance

Where Used

The AT5600 offers two basic alternative ways to confirm that the transformer has been assembled properly, with the appropriate number of primary and secondary turns.

Turns ratio is the preferred test for signal, pulse, and switched mode power transformers, where the normal operating conditions require only small excursions of the B-H curve, never extending beyond the linear regions.

Where the magnetic coupling between the primary and secondary is poor, it is preferable to measure the turns ratio by inductance. This test measures the inductance of both the primary and secondary and calculates the turns ratio from these measured inductance values so removes the effects of leakage inductance, magnetising current and dc resistance of windings. The TRL test then returns the square root of primary inductance over secondary inductance.

Clearly a turns ratio test (by voltage TR or inductance TRL) cannot tell you the actual number of turns on a winding, only the ratio between one winding and the next. You should therefore have at least one inductance test in your program to give confidence that the absolute number of turns is correct as well as the ratio.

Measurement Conditions

The inductance of a winding can often depend upon the flux density in the core/windings. Since during measurement, the flux density will depend upon the signal energizing the winding, it is important that both windings are energized at the same level. This will ensure that both inductances are measured along the same region of the B/H curve of the core, to give a true ratio.

Please be aware that TRL is best suited for transformers with around 3:1 to 1:3 ratios. Higher ratios will mean that measurement conditions would not be ideal on both sides, due to the inductance difference so accuracy of ratio will lessen.

Setting the Test Parameters

To do this you will need to know the inductance of the primary and secondary windings.

The optimum test conditions are chosen for an inductance value that is between the primary and secondary (L_m).

$$L_m = \sqrt{L_p \times L_s}$$

Where:

L_m = Intermediate inductance

L_p = Primary inductance

L_s = Secondary inductance

V_p = Primary voltage

V_s = Secondary voltage

V_m = Intermediate voltage

N_p = Primary turns

N_s = Secondary turns

Look up the recommended test signal for this inductance.

The recommended test conditions depend on the Intermediate inductance of both windings; they are given in the table in Section 7.7 LS,

Enter the recommended frequency for this inductance as the test frequency.

The primary and secondary voltages can be calculated from the following:

$$V_s = V_m \sqrt{\frac{N_s}{N_p}} \quad V_p = V_m \sqrt{\frac{N_p}{N_s}}$$

If you calculate V_s or V_p to be greater than 5V, you should set 5V as your test signal. If you calculate V_s or V_p to be less than 1mV, you should set 1mV as your test signal.

AUTO secondary test conditions

Optionally, The AT Editor will also allow you to specify the V/F on the primary, and AUTO conditions for the secondary.

With this selected, the AT will energize secondary for the L measurement at the same voltage as if the primary was energized.

In summary, the AT process for the AUTO setting is.

- 1, Measure the inductance and voltage on the primary.
- 2, Leaving the generator on, measure the secondary voltage
- 3, Connect the generator to the secondary at the voltage measured in step 2 and measure the inductance.

Specifying the Test Limits

When specifying turns ratio tests, it is preferable to avoid limits which are unnecessarily tight, and which may therefore lead to measurement difficulties.

For example, if two equal secondary windings should have 10 turns each, the ratio should be 1:1. One turn in error would produce a ratio error of 10% or -10% (i.e., 11:10 or 10:11), and therefore limits of +5% and -5% would be suitable to detect the error.

Please also see

AT dotNET Editor manual (98-125 2.5.13) for specific advice on programming the test

10.2.5 for test accuracy specification

7.15. Z, ZB – Impedance, Impedance with Bias

Where Used

The impedance test measures the impedance of a transformer winding by applying a specified voltage and frequency and by measuring the current that flows, calculating the magnitude of the complex impedance.

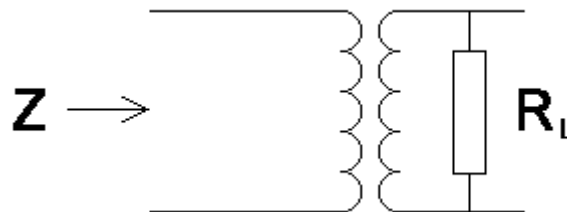

Measurement Conditions

Z or ZB can be measured with or without a load on the secondary.

The AT does not need any “knowledge” of the load, as it is the effective Z of the whole transformer from the point of the selected windings that is reported.

The test voltage is applied to the input winding, and the voltage and current measured. From the measured results the impedance is calculated.

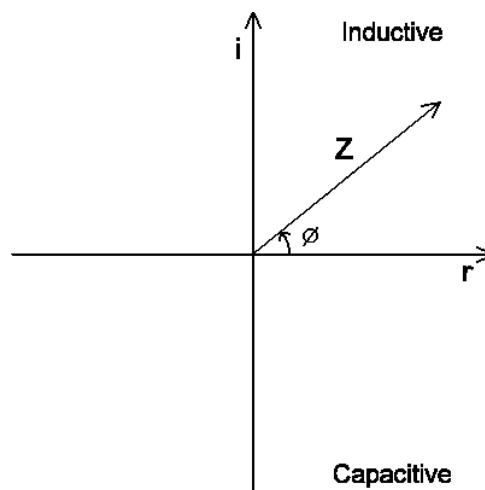

Please also see

AT dotNET Editor manual (98-125 2.5.14+15) for specific advice on programming the test

10.2.23 for test accuracy specification

7.16. R2 – DC Resistance Match

Where Used

The DC resistance match test – as opposed to an ordinary DC resistance measurement (R) - is used on audio and telecommunications transformers, where it is important that the resistance of different pairs of windings is controlled and matched to a specified ratio. The absolute value of the resistances may be of less importance to the performance of the transformer than the match between two resistances.

Measurement Conditions

To measure DC resistance match, the tester makes two DC resistance measurements (see the R test) and compares the two results. Limits for the match of the two measured resistances may be set in terms of the ratio between them (e.g., $1:1 \pm 5\%$).

By adding further DC resistance match tests to the test program, any number of DC resistances can be tested for match.

Choosing Test Conditions

For optimum accuracy and performance, use the test conditions shown in the DC resistance section of this chapter for each of the two windings.

Choosing Test Limits

The test limits are the specific resistances for both X and Y terminals together with + and – percentage limits.

Use the PC Editor's 'Measure' button (together with a sample part) if you are unsure of the resistance values.

Please also see

AT dotNET Editor manual (98-125 2.5.16) for specific advice on programming the test

10.2.18 for test accuracy specification

7.17. L2 – Inductance Match

Where Used

The inductance match test calculates the ratio between two inductances on two windings. An equivalent series inductance measurement is performed on each winding by measuring the complex impedance.

This test is suitable for switched mode power supply transformers, and audio & telecommunication transformers. It checks matching between windings.

Measurement Conditions

When calculating, inductance match the tester performs two inductance measurements. Firstly, the unit applies an AC voltage across the first winding; it then measures the voltage across and the current through the winding using harmonic analysis. The measured voltage is divided by the current to obtain a complex impedance and the inductance is calculated. This is then repeated for the second winding. The inductance match is the ratio of first to second winding inductance.

The test signal can have a frequency in the range 20Hz to 3MHz, and an amplitude from 1mV to 5V.

Generally, it is not necessary to measure the inductance at the normal operating conditions of the transformer, which could involve, for example, voltage levels of hundreds of volts. This is because the B-H curve can normally be assumed to be linear in the operating region, and the inductance measured at a low level represents the inductance that will appear in use.

Also, it can usually be assumed that the inductance value does not vary significantly with frequency. Therefore, although high frequencies are available with the tester, measurement frequencies above a few hundred kilohertz should be used with caution. This is because the errors caused by the stray inductance and capacitance of your fixture may become much more significant at these frequencies. Compensation can be used to eliminate these errors.

The following table suggests suitable test conditions for different values of expected average inductance:

Average Inductance (Geometric Mean)			Preferred test signal	
			Frequency	Voltage
100nH	→	1uH	300KHz	10mV
1uH	→	10uH	100KHz	30mV
10uH	→	100uH	30KHz	50mV
100uH	→	1mH	10KHz	100mV
1mH	→	10mH	1KHz	100mV
10mH	→	100mH	100Hz	100mV
100mH	→	1H	100Hz	300mV
1H	→	10H	50Hz	1V
10H	→	100H	50Hz	5V
100H	→	1KH	50Hz	5V
1kH	→	10KH	20Hz	5V

Test Conditions for Inductance Match Measurement

Wherever possible, this table should be used for all inductance tests. The inductance range should be chosen based on minimum value of inductance expected.

When choosing the test conditions, the following potential problems should be considered:

Current levels

The upper voltage limits should be chosen to give a maximum current level of about 100mA RMS for the lowest inductance expected. In some cases, this current may cause core saturation, and a lower voltage should be used. The minimum voltage level must be chosen so that the test current does not become so low that it cannot be sensibly measured. The lower voltage limits in the table above always give test currents higher than 3µA RMS.

Self-Resonant Frequency

At lower frequencies, the capacitance of the windings can normally be ignored because its impedance is much higher than that of the inductance. However, at extremely high frequencies, this is not so, the capacitance dominates, and inductance cannot be measured. The self-resonant frequency of the transformer is the change-over point between these two regions.

Normally to get a good measurement of inductance, the test frequency should be less than 20% of the resonant frequency of the transformer.

In general, high values of inductance will have a high inter-turn capacitance and hence a low resonant frequency. Where there is a choice of test frequencies always use the lower value, to minimize any problems due to self-resonance.

Please also see

AT dotNET Editor manual (98-125 2.5.17) for specific advice on programming the test

10.2.18 for test accuracy specification

Non-linear inductance

Normally inductance measurements should be used for transformers where the B-H characteristics are linear.

However, if inductance measurements are attempted for instance with line frequency transformers where the core material is non-linear even at low signal levels, the measured results can be highly dependent on the applied test signal.

This can be a problem when trying to compare measurements made on commercially available impedance bridges, or component testers, with measurements made using the AT Series testers. The test signal in such bridges is usually determined within the instrument and is often at a fixed frequency and at a voltage level which is not guaranteed to be constant for all value of inductance.

Usually, if the actual test conditions of the bridge can be determined, and the tester is then programmed to deliver the same test conditions across the inductance the results will then agree. (See also the comments below on differences caused by the choice of equivalent circuit)

Equivalent circuit

Inductance is always measured as part of a complex impedance; the result being expressed in terms of either a series or parallel equivalent circuit. Note that, for any given winding, the inductance values for two circuits are not necessarily the same; this should be born in mind when specifying the test limits.

7.18. C2 – Capacitance Match

Where Used

The interwinding capacitance match test calculates the ratio between two capacitance measurements on two groups of windings. It is measured by applying a specified AC voltage between two separate windings and the voltage across and current flow between the two windings is measured to obtain a complex impedance. This is performed to the two groups in turn.

This test is suitable for switched mode power supply, audio, and telecommunication transformers. It checks that the windings are installed in the correct positions on the bobbin.

Measurement Conditions

When calculating the capacitance match, the tester performs 2 capacitance measurements. Firstly, the tester applies an AC voltage between first group of windings to be tested, usually with all taps on each winding shorted together. It then measures the voltage between the windings, and the resulting current using harmonic analysis. Dividing the voltage by the current gives the inter-winding impedance, from which the capacitance may be calculated. This is then repeated for the second winding group. The capacitance match is the ratio of first to second winding group capacitances.

The test voltage can be in the range of 1mV to 5V at a frequency of 20Hz to 3MHz.

The table below gives the recommended test conditions for different values of average capacitance:

Average Capacitance (Geometric Mean)			Preferred test signal	
			Frequency	Voltage
1 pF	→	10 pF	100 KHz	5 V
10 pF	→	100 pF	100 KHz	5 V
100 pF	→	1 nF	10 KHz	5 V
1 nF	→	10 nF	1 KHz	5 V
10 nF	→	100 nF	100 Hz	5 V

The Test Conditions for Capacitance Match Measurement

When choosing the test conditions, the following potential problems should be considered:

Current levels

For larger capacitances, particularly at higher frequencies, the current flowing during the measurement can be extremely high, and similarly the measured current could also be exceedingly small for small capacitances at lower frequencies and voltages.

Where possible, you should use the recommended test signal levels in the table above to ensure that the currents which flow can be measured accurately.

Non-linear Capacitance

Normally non-linearity in the stray capacitance of transformers is not a problem, and therefore capacitance is measured with as large a voltage as possible.

Equivalent Circuit

As with inductance, capacitance is measured as a complex impedance, and therefore the result can be expressed in terms of either a series or a parallel equivalent circuit.

It was explained in section 7.7, that parallel and series equivalent inductance do not necessarily have the same values. The same is true for capacitance; parallel and series equivalents can also be different.

The tester uses a parallel equivalent circuit for capacitance measurements and does not give you a choice of a series equivalent.

This will present no problems, as on most transformers the difference between the two values is usually negligible and can be ignored.

Please also see

AT dotNET Editor manual (98-125 2.5.18) for specific advice on programming the test

10.2.18 for test accuracy specification

7.19. GBAL – General Longitudinal Balance

Where Used

The general longitudinal balance test is intended to measure what is effectively the Common Mode Rejection Ratio of a transformer designed to connect to a balanced line. Two measurements are performed each by applying a voltage to the transformer and measuring the resulting voltage to calculate the CMRR. To overcome the differences of three standard methods of measuring the CMRR the GBAL dialogue box has a separate group of terminals X and Y for the first and second measurements, respectively. The preferred method of measurement is the LBAL test for which Voltech provide a separate test specifically for this measurement. This test is suitable for audio & telecommunication transformers and checks the effective common mode rejection ratio of the transformer.

Measurement Conditions and Types

Unfortunately, there are several published specifications for measuring longitudinal balance. These are all different, and potentially give different results for the same transformer.

To allow each user the freedom to test to his preferred method, the GBAL test has been configured with the greatest flexibility. It therefore consists of two separate measurements which the user can program, and the result is the ratio between the two expressed in dB.

Operation

For the reasons outlined above, the test consists of two separate user programmed measurements, each with its own 'energized' and 'measured' terminals. This approach is illustrated below with reference to three standard methods:

- 1) Preferred method (the method of the LBAL test, used by many transformer manufacturers)

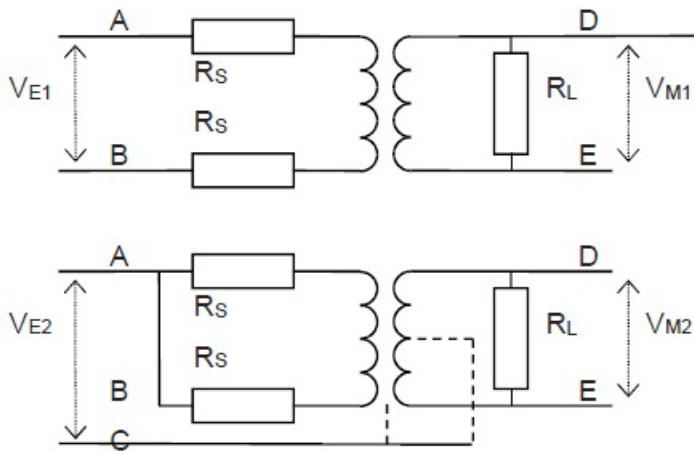

Measurement				
	Energized		Measured	
	Hi	Lo	Hi	Lo
1	A	B	D	E
2	A+B	C	D	E

- 2) IEEE 455 method (used in Canada, Europe, and ROW)

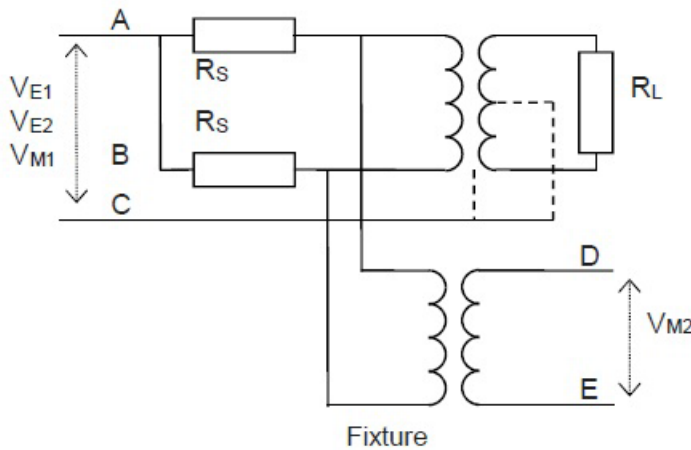

Measurement				
	Energized		Measured	
	Hi	Lo	Hi	Lo
1	A+B	C	A	C
2	A+B	C	D	E

3) FCC 68.310 method (used in USA)

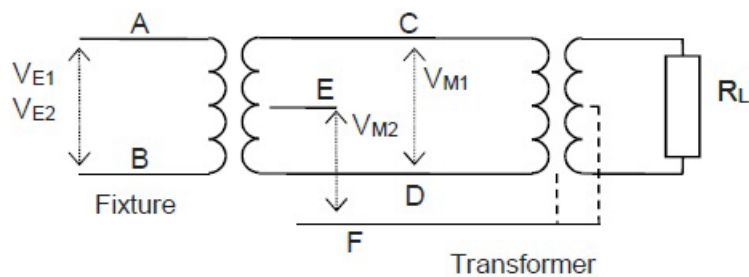

Measurement				
	Energized		Measured	
	Hi	Lo	Hi	Lo
1	A	B	C	D
2	A	B	E	F

The source and load resistors (and the fixture transformer for the IEEE and FCC methods) are assumed to be on the fixture but are not shown on the Editor schematic. They are switched in circuit using an OUT test that must be inserted in the program before the GBAL test. (The relay patterns associated with inserting and removing fixture resistors have deliberately not been included in the GBAL test dialogue for two reasons: a) it would make the dialogue too complicated, and b) it is not always necessary - e.g., in the case of a fixture where the resistors are permanently fitted in circuit).

After the two measurements, have been taken, the longitudinal balance is calculated from the ratio of the two outputs:

$$GBAL = 20 \log | VM1 / VM2 |$$

+ (optionally) compensation for test fixture scaling

Please also see
 AT dotNET Editor manual (98-125 2.5.19) for specific advice on programming the test
 10.2.19 for test accuracy specification

7.20. LBAL – Longitudinal Balance

Where Used

The longitudinal balance test is Voltech's preferred method to measure what is effectively the Common Mode Rejection Ratio of a transformer designed to connect to a balanced line. Two measurements are performed each by applying a voltage to the transformer and measuring the resulting voltage to calculate the CMRR. This test is suitable for audio & telecommunication transformers and checks the effective common mode rejection ratio of the transformer.

Measurement Conditions

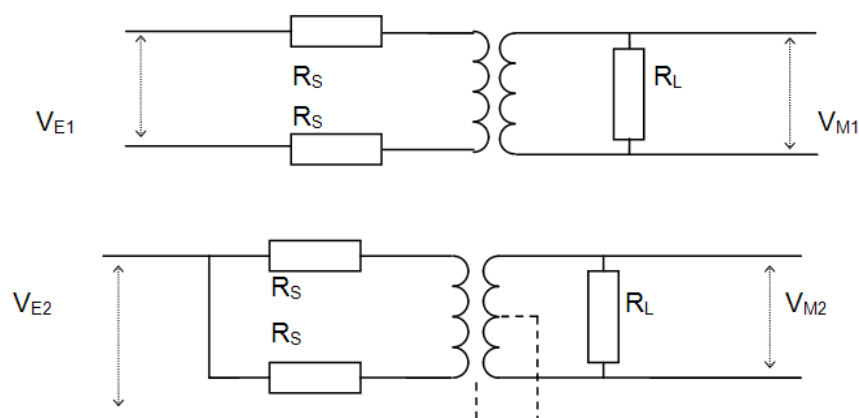

$$\text{LBAL} = 20 \text{ Log } [V_{m1} / V_{m2}]$$

The source and load resistors are assumed to be on the fixture but are not shown on the editor schematic. They are switched in circuit using an OUT test that must be inserted in the program before the LBAL test. (The relay patterns associated with inserting and removing fixture resistors have deliberately not been included in the LBAL test dialogue for two reasons: a) it would make the dialogue too complicated, and b) it is not always necessary - e.g., in the case of a fixture where the resistors are permanently fitted in circuit).

The test consists of two measurements: a) with the input applied as a differential signal, and b) with the input applied as a common mode voltage relative to a common Low point, which could be the centre tap of the secondary winding, the transformer core or an interwinding screen. In each case the output is measured, and the longitudinal balance is calculated from the ratio of the two outputs.

Please also see

AT dotNET Editor manual (98-125 2.5.20) for specific advice on programming the test

10.2.20 for test accuracy specification

7.21. ILOS – Insertion Loss

Where Used

The Insertion loss test measures the output power delivered by a transformer to a load, relative to the maximum power theoretically available. A voltage is applied to the input winding and the input/output voltages are measured to calculate the loss.

This test is suitable for audio & telecommunication transformers and checks the effective losses in the transformer when used for its application.

Measurement Conditions

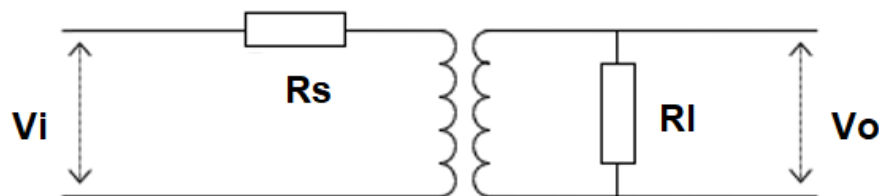

$$ILOS = 10 \text{ Log } [(V_i * V_i * R_I) / (4 * V_o * V_o * R_s)]$$

The source and load resistors are assumed to be on the fixture but are not shown on the Editor schematic.

They can be switched in circuit using an OUT test that must be inserted in the program before the ILOS test.

Alternatively, they can be permanently fitted in circuit. This can influence other tests, most obviously DCR. Please see later section on a programming/ Fixturing tip for this.

The test voltage is applied to the input winding, and the voltages measured on the input and output windings.

From the ratio of input and output voltages, and the resistance values (specified by the user in the test dialogue), the insertion loss is calculated.

Please also see

AT dotNET Editor manual (98-125 2.5.21) for specific advice on programming the test

10.2.20 for test accuracy specification

7.21.1. Fixturing and Programming tip for using Source Resistors

The use of the source and load resistors will obviously have an impact on your other measurements, which could be accommodated for in adjusting suitable limits for the known configurations and loading.

Alternatively, you can construct the fixture to use two AT node connections to connect to one transformer pin: one with a resistor, and one without.

Consider the simple example below of an inductor with terminals A and B. An additional dummy ARES winding is added. This represents the A terminal connected with a resistor in series to the AT nodes.

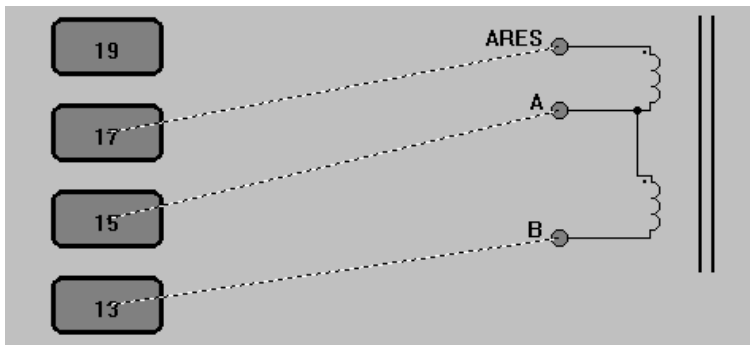

2-Wire connections.

In a simple two wire connection, this would be constructed on the fixture as below. Tests requiring the resistor would use the ARES-B nodes. You can still perform a DCR direct measurement of the inductor using the true A+B nodes.

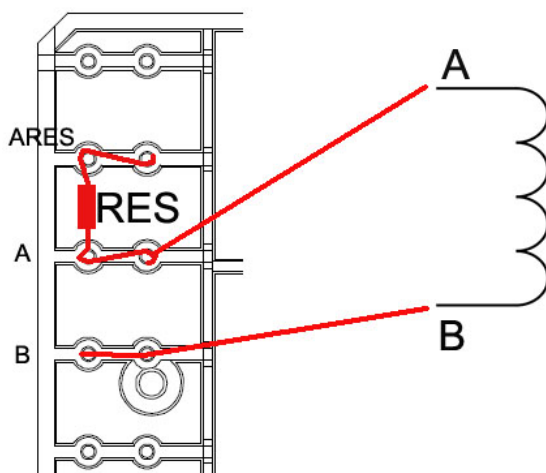

4-Wire connections

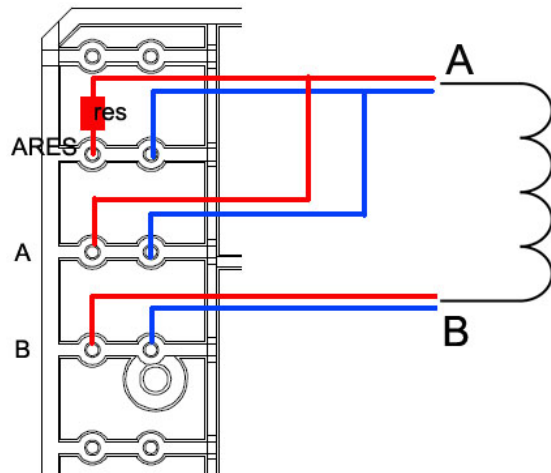

If you wish to maintain full 4 wire connection to A and B, then the above wiring configuration can be used.

7.22. RESP – Frequency Response

Where Used

The frequency response test, RESP, may be used to check that the variation in power loss of a telecommunications or audio transformer over a specified frequency range is less than specified limits.

Measurement Conditions



The RESP test consists of many Insertion Loss (ILOS) tests repeated at different frequencies.

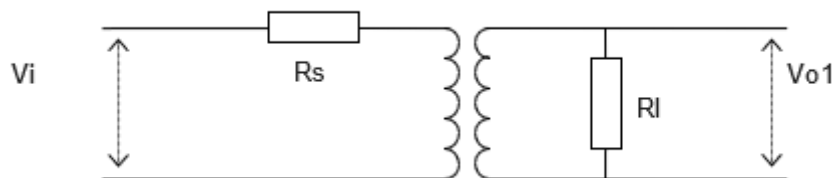

The resistors shown are fitted to the test fixture and should be switched out of circuit when making other measurements such as resistance and inductance. This can be done by fitting relays to the fixture and switching them at appropriate points in the test program using OUT tests.

The first ILOS test is made at a reference frequency that is usually near the middle of the band of frequencies of interest. The result of this test is the 0dB reference level. Further ILOS tests are then carried out at user selected frequencies and the results referred to the reference dB level.

If all the referred ILOS results are at or inside the specified limits, the result of a RESP test is the preferred ILOS result that is closest to the limit. If any of the referred ILOS results are outside the specified limits, the RESP result is the preferred ILOS result that is furthest away from the limit.

Please also see
AT dotNET Editor manual (98-125 2.5.22) for specific advice on programming the
test
10.2.21 for test accuracy specification

7.23. RLOS – Return Loss

Where Used

The Return loss test measures the impedance mismatch between the transformer and a transmission line of a specified impedance. It is defined as

$$\text{RLOS} = 10 \text{ LOG} [(\text{Incident Power}) / (\text{Reflected Power})]$$

An ideal transformer would thus have a large RLOS value, which is counter intuitive, given the name.

In the case of the AT5600, RLOS is calculated from a measurement of the complex impedance (Z_l) on the energised winding, and the specified reference (Z_r) impedance on the secondary.

This test is suitable for audio & telecommunication transformers and checks the effective input impedance of the transformer in the application.

Measurement Conditions



$$\text{RLOS} = 20 \log (| Z_r + Z_l | / | Z_r - Z_l |)$$

The load resistor is assumed to be on the fixture, but not shown on the Editor schematic (although its real and Imaginary values must be entered as part of the test programming) .

It can be switched in circuit using an OUT test that must be inserted in the program before the RLOS test.

It is also possible to use a fixture where the resistor is permanently fitted in circuit, but this would of course affect other measurements (most obviously, DCR on the secondary), but is feasible, the limits could be adjusted to accommodate this.

The test voltage is applied to the input winding, and the voltage and current measured. From the measured results, and the reference impedance value (specified by the user in the test dialogue), the return loss is calculated.

The impedances used are complex, where:

$$Z_R = R_R + j X_R$$

$$Z_l = R_l + j X_l$$

Please also see

AT dotNET Editor manual (98-125 2.5.23) for specific advice on programming the test

10.2.22 for test accuracy specification

7.24. ANGL – Impedance Phase Angle

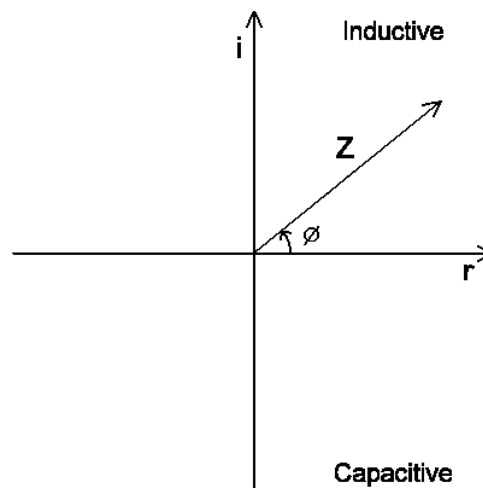

Where Used

The impedance phase angle test measures the angle ϕ of the impedance vector Z , as shown in the diagram.

It represents the phase difference between the fundamental current flowing through a winding and the fundamental voltage across it.

This test is normally used for audio and telecommunication transformers along with the Z test to check the complex impedance presented to the transformers input and output.

Measurement Conditions

An AC voltage is applied across the winding under test, the complex impedance is determined from measurement of the test voltage and current flowing.

To set the test voltage or current you will need to know the expected impedance of the winding at the test frequency.

Select the test voltage or current from the table below; find the correct impedance range for your winding and read off the test voltage or current.

Inductive parts will return a positive phase angle, and capacitive parts will return a negative phase angle.

Impedance Range	Test Voltage	Test Current
1 M Ω to 100 k Ω	5 V	-
100 k Ω to 10 k Ω	5 V	30 μ A
10 k Ω to 1 k Ω	5 V	300 μ A
1 k Ω to 100 Ω	3 V	3 mA
100 Ω to 10 Ω	500 mV	10 mA
10 Ω to 1 Ω	100 mV	50 mA
1 Ω to 100 m Ω	10 mV	50 mA
100 m Ω to 10 m Ω	1 mV	50 mA
10 m Ω to 1m Ω	-	50 mA

Please also see

AT dotNET Editor manual (98-125 2.5.24) for specific advice on programming the test 10.2.24 for test accuracy specification

7.25. PHAS – Interwinding Phase

Where Used

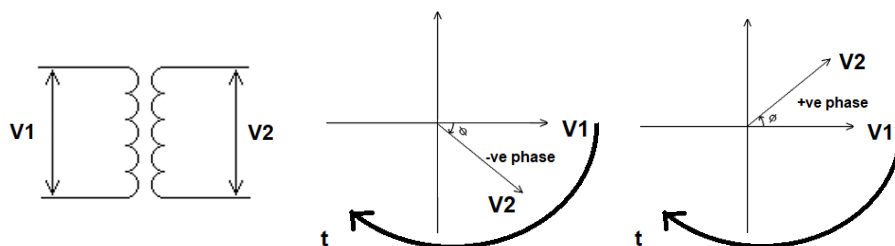

This test is useful for most types of transformers, although unusual with line frequency transformers and tests for the phase angle between windings.

It is most useful for determining the phase effect of audio and telecommunications transformers when placed in a transmission line.

When V2 lags behind V1 the results will be a negative phase, and vice versa.

Measurement Conditions

When programming the test enter the test frequency, choose the test voltage from the following table.

When selecting your energized winding, check that your transformer does not have a large step-up turns ratio between this winding and any other windings as this may cause high voltages to be present during the test.

If this is the case, then energize the winding with the most turns.

Impedance of Energized Winding Max	Impedance of Energized Winding Min	Test Voltage
1 M Ω	100 k Ω	5 V
100 k Ω	10 k Ω	5 V
10 k Ω	1 k Ω	5 V
1 k Ω	100 Ω	3 V
100 Ω	10 Ω	0.5 V
10 Ω	1 Ω	100 mV
1 Ω	100 m Ω	10 mV
100 m Ω	10 m Ω	1 mV

Convention for returned result

For phase tests, the convention of the result returned by the AT depends on the mean of the limits you have requested.

The Mean of the Min and max limits are calculated, and the results will be expressed within the range (Mean – 180 deg) and (Mean +180deg)

For example

A, if the Limits are -5 Deg to + 5 Deg then the mean is 0Deg and the result will be in the range -180 deg to 180 deg.

B, if the Limits are 85 Deg to 95 Deg then the mean is 90 Deg and the result will be in the range -90 deg to +270 deg.

B, if the Limits are 40 Deg to 60 Deg then the mean is 50 Deg and the result will be in the range -130 deg to +230 deg.

Please also see
10.2.25 for test accuracy specification

7.26. OUT – Output to User Port

Where Used

OUT is used where additional switching (other than performed by the nodes of the AT) is required for parts of the test program.

The User Port on the tester has associated with it 6 'Relay Driver' outputs. The OUT test allows programming of the User Port relay driver outputs to perform additional relay switching as part of the test program.

An example of this would be an application where a transformer has two separate primary windings. An OUT test could be used to connect them in series, allowing them to be tested as a single primary with twice the working voltage.

A second example is the switching of additional resistors mounted on the test fixture allowing tests to be included in a program on a transformer with a loaded secondary winding.

Specifying Test Conditions

User Port Outputs

Each of the relay driver outputs (numbered 0 – 5) is an open collector output which can be set to **On** or **Off** as desired:

On = Connected to GND (0V)

Off = Open circuit (Floating)

Note:

The relay drivers are set as and when the tester encounters an OUT test.

The settings given will latch until another OUT test is encountered.

Therefore, if the settings are required for one part of the test program only, 2 OUT tests will be required, 1 to turn the appropriate relay drivers on and 1 to turn them back off.

Please also see

AT dotNET Editor manual (98-125 2.5.26) for specific advice on programming the test,

7.27. IR - Insulation Resistance

Where Used

An Insulation Resistance check is recommended as good practice for most transformers to check the integrity of the insulation between separate windings, or between a winding and a screen.

It is used where winding isolation is a part of the functionality of the transformer, but not part of a safety requirement, for which a Hi-Pot (EHT) test is preferred.

It would therefore be used, for example, between two primary windings, or between two secondary windings. Transformers with screens included for additional safety failsafe protection may also benefit from IR tests between primary and screens.

Whilst it may seem similar in concept to HPDC or HPAC testing it differs in subtle ways. The IR test has no concept of a ramp or dwell time, so is faster to execute.

While HPAC/HPDC measures current and can fail on measurement limits (or flash over), it is typically used for detecting flashovers. IR gives a reading that gives more assurance on the longevity of the insulation over time, even if it passes a HPDC test.

The common industry standard for IR tests is for them to be performed at 500V DC, but the AT5600 allows 100V -7000 VDC should you require it.

Example Use Case on a multi winding transformer.

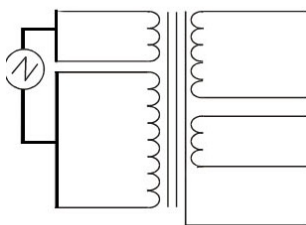

IR1 – Pri A to Pri B @ 500V

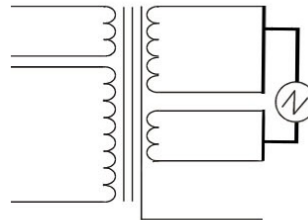

IR2 – Sec A to Sec B @ 500V

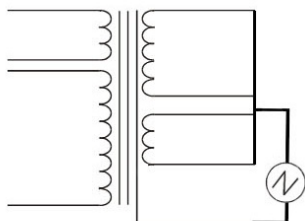

IR3 Sec A+B to Screen @500V

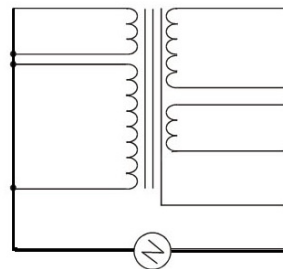

HPAC – Pri A+B to Sec A + B + Screen @2500V

Measurement Conditions

To measure insulation resistance, the tester applies a DC voltage between two groups of windings, with the windings in each group being shorted together. Each group may contain as many windings as you wish.

The voltage and current are measured; dividing the voltage by the current gives the insulation resistance.

You can also command the tester to perform a compensation measurement on the empty fixture at the start of a test run. This is recommended as it will allow the tester to subtract the errors due to the fixture from subsequent measurements, to give more accurate results.

The test voltage may be chosen in the range from 100V to 7kV.

Normally however, you would perform the test with a voltage just greater than twice the highest possible peak working voltage on the winding. Therefore, for example, to check the isolation between the two primary windings of a line frequency transformer, which could be connected in series and operated at 240V, 800V would be a suitable test signal.

Specifying the Test Limits

Although the tester is capable of measuring insulation resistance values greater than $1\text{G}\Omega$, there is no need to specify so high a value to check that windings are isolated.

In many cases, specifying a lower value will speed up the execution of the test. A value of $100\text{M}\Omega$ is suitable for most applications.

Best Practice for multiple winding or large transformers.

After any HPAC, HPDC or IR test, the unit will turn off the sources, and switch in an internal discharge resistor to remove any latent voltages on any windings used in the test.

Any voltage present is monitored until it has decayed, then the relays opened ready for the next test. This is defined in 9.2.3 "Voltage Present Error."

On large transformers where one winding (or a screen or core connection) are not used in the high voltage test, then these are left floating with respect to ground.

As the controlled discharge only applies to nodes used in the test, these unused nodes could be left in a dangerous state, especially if the UUT is large or highly capacitive.

Hence it is **always best practice** to use **ALL available nodes** in a high pot test. Typically, by selecting the winding to test as HI, and all others to LO.

This ensures that the whole transformer is electrically controlled during the test, and fully discharged after. This prevents hot switching of the relays in the AT which can potentially cause damage on the subsequent tests if floating voltages are left.

Please also see

AT dotNET Editor manual (98-125 2.5.34) for specific advice on programming the test and

10.2.11 for test accuracy specification

7.28. HPDC - DC HI-POT (EHT)

Where Used

Hi-Pot or EHT testing (to check for insulation breakdown between windings or between windings and the screen or core) is often specified for power line transformers or for switched mode power transformers in applications where safety is important. It is typically performed between all primary windings connected, and all secondary windings plus the screen connected.

DC Hi-pot is preferred where the transformer has a high natural capacitance, and so a HPAC test, especially at higher voltages, would draw too much current. However, HPDC can be used on any transformer.

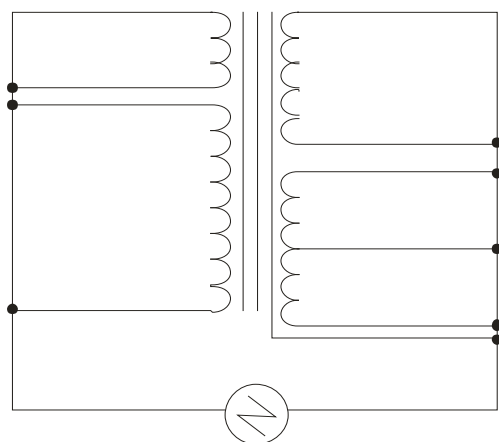

Specifying the Measurement

During the test, a DC voltage is applied across two groups of windings with the windings in each group being shorted together. The voltage and current are monitored throughout the dwell time; if either the test voltage cannot be maintained, or the current is too large, then a failure will be recorded.

In programming the tester, you may select the voltage (from 100V to 7KVdc), the current trip level (1 μ A to 3mA), and the ramp up and dwell times, all to suit the specification of the transformer under test.

Many transformer specifications require Hi-Pot testing to be carried out with a dwell time of 60 seconds. Although the transformer must be designed and constructed to meet this, it is widespread practice to reduce the dwell time for production testing. This is recognized by IEC 742, which permits a dwell time of 2 seconds for production testing. Although not required by IEC 742, it is good practice to increase the test voltage by, for example, 10% when performing reduced-time testing, to provide additional security for the test.

IEC742 has been replaced by IEC61558, which specifies 1 second for production testing. Details are available on the IEC website (<http://www.iec.ch>)

Best Practice for multiple winding or large transformers.

After any HPAC, HPDC or IR test, the unit will turn off the sources, and switch in an internal discharge resistor to remove any latent voltages on any windings used in the test.

Any voltage present is monitored until it has decayed, then the relays opened ready for the next test. This is defined in 9.2.3 "Voltage Present Error."

On large transformers where one winding (or a screen or core connection) are not used in the high voltage test, then these are left floating with respect to ground.

As the controlled discharge only applies to nodes used in the test, these unused nodes could be left in a dangerous state, especially if the UUT is large or highly capacitive.

Hence it is **always best practice** to use **ALL available nodes** in a high pot test. Typically, by selecting the winding to test as HI, and all others to LO.

This ensures that the whole transformer is electrically controlled during the test, and fully discharged after. This prevents hot switching of the relays in the AT which can potentially cause damage on the subsequent tests if floating voltages are left.

Please also see
AT dotNET Editor manual (98-125 2.5.27) for specific advice on programming the test
10.2.12 for test accuracy specification

7.29. HPAC - AC HI-POT (EHT)

Where Used

Hi-Pot or EHT testing (to check for insulation breakdown between windings or between windings and the screen or core) is often specified for power line transformers or for switched mode power transformers in applications where safety is important.

It is typically performed between all primary windings connected, and all secondary windings plus the screen connected.

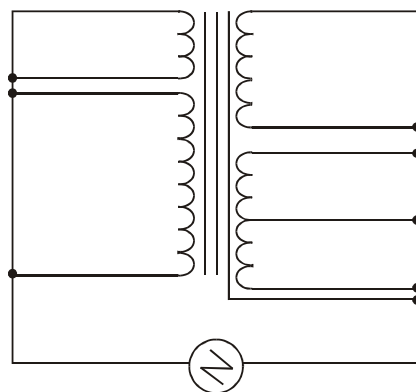

Specifying the Measurement

During the test, an AC voltage is applied across two groups of windings with the windings in each group being shorted together. The voltage and current are monitored throughout the dwell time; if either the test voltage cannot be maintained, or the current is too large, then a failure will be recorded.

In programming the AT5600 you may select the voltage (from 100V to 5kVrms), the frequency (50Hz / 60Hz at the full voltage, or up to 1kHz at reduced voltage), the current trip level (10 μ A to 30mA peak), and the ramp up and dwell times, all to suit the specification of the transformer under test.

Many transformer specifications require Hi-Pot testing to be carried out with a dwell time of 60 seconds. Although the transformer must be designed and constructed to meet this, it is widespread practice to reduce the dwell time for production testing.

This is recognized by IEC 742, which permits a dwell time of 2 seconds for production testing. Although not required by IEC 742, it is good practice to increase the test voltage by at least 10% when performing reduced-time testing, to provide additional security for the test.

IEC742 has been replaced by IEC61558, which specifies 1 second for production testing. Details are available on the IEC website (<http://www.iec.ch>).

During a Hi-Pot test, the Wattage is continuously monitored and adjusted to provide the correct output. If the programmed output voltage cannot be maintained, the tester will automatically display 'FAIL,' illuminate the red indicator, return a 'FAIL' to the server (if used), and sound a warning buzzer (if enabled). This method complies with the production requirements of EN61558-1 (1998), UL1411, 5th Edition and others.

Best Practice for multiple winding or large transformers.

After any HPAC, HPDC or IR test, the unit will turn off the sources, and switch in an internal discharge resistor to remove any latent voltages on any windings used in the test.

Any voltage present is monitored until it has decayed, then the relays opened ready for the next test. This is defined in 9.2.3 "Voltage Present Error."

On large transformers where one winding (or a screen or core connection) are not used in the high voltage test, then these are left floating with respect to ground.

As the controlled discharge only applies to nodes used in the test, these unused nodes could be left in a dangerous state, especially if the UUT is large or highly capacitive.

Hence it is **always best practice** to use **ALL available nodes** in a high pot test. Typically, by selecting the winding to test as HI, and all others to LO.

This ensures that the whole transformer is electrically controlled during the test, and fully discharged after. This prevents hot switching of the relays in the AT which can potentially cause damage on the subsequent tests if floating voltages are left.

Please also see

AT dotNET Editor manual (98-125 2.5.28) for specific advice on programming the test and

10.2.13 for test accuracy specification

7.30. SURG - Surge Stress

Where Used

This test may be used to detect a short circuit between adjacent turns in a winding. It is applicable to any transformer but is particularly suitable for transformers with many turns using exceptionally fine wire. Fine wire has the double potential to fail, as it will have thinner enamel, and typically be used to wind a high number of turns – this increased length and thinness give much more chance for a manufacturing fault to occur.

For such wire, the enamel coating is very thin, and there is a danger that it will be scratched giving rise to exposed copper. In some cases, the scratch does not immediately cause a shorted turn, but will leave a weak spot which may eventually fail. A higher-than-normal test voltage is used to help find faults which may occur later in use.

Measurement Method

Each SURG test can be programmed to consist of many DC impulses.

It is recommended to use a small number of impulses (normally 3) to demagnetize the core before taking the reading from the last impulse.

More impulses may also help find defective wire insulation.

For multiple impulses, The AT5600 will return the LOWEST result of all the impulses programmed.

For each impulse, the AT5600 will charge an internal capacitor to the programmed test voltage. This stored DC charge will then be suddenly discharged into the part under test and the resulting transient voltage will be analysed. The surge result is the area under the waveform curve. A typical transient waveform is shown below.

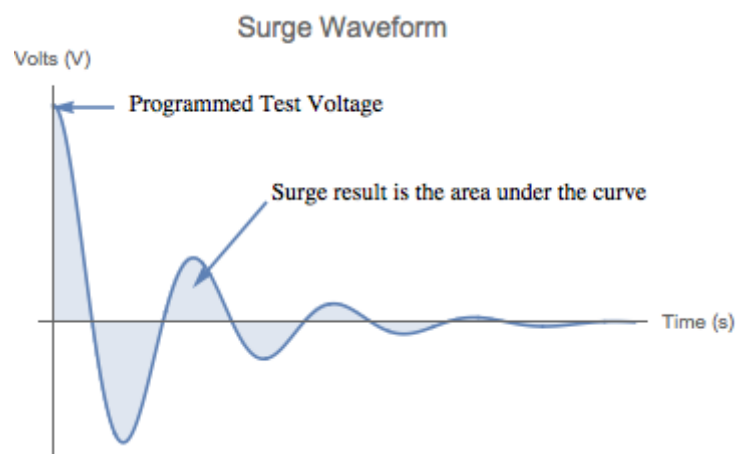

Transient Analysis

During the decay phase after the impulse has been fired, the AT5600 measures both the voltage amplitude along the transient, and the time over the decay.

The AC waveform (and frequency/amplitude/decay rate) is a function of the characteristics of your UUT and the AT5600 Capacitors used to discharge the DC spike.

Obviously, an ideal inductor with no losses or resistance would resonate indefinitely.

A good "real" transformer will have a clean and sustained transient with a long decay period.

A bad transformer with a shorted turn will have a heavily damped response with a shorter decay period.

The measurement performed is to calculate the 'area' underneath the graphical plot of the decaying transient.

For the calculation used, both negative peaks and positive peaks add to the total area. The area, measured in Volts-seconds, is much smaller for the faulty winding with a shorted turn.

Specifying the Test Limits

It is difficult to predict the Volts-seconds 'area' under the curve from theoretical calculations, so the limits should be calculated from measurements taken from a known good part.

The recommended method is to use the Measure Mode to obtain some values from several parts.

Notes and Hints on use of the SURG test

Even though the energizing pulses are applied to one winding, it is important to note that this voltage will then be induced on to all windings on the transformer under test, in the same Volt/turn ratio.

To prevent damage to the UUT, or to the AT5600, the SURG test should always be applied to the winding with the greatest number of turns. You should also check that the design of the other windings that will be energized can withstand the induced voltage.

It is also important to note that the Volt Second numerical result of the test is characteristic of the whole transformer, not just the energized winding. The Surge test tests all windings on the transformer.

Please also note that the maximum Surge signal is dependent on the inductance of the part under test if the LS inductance is below 125 uH. Please see 10.2.17 for definition of this.

Please also see

AT dotNET Editor manual (98-125 2.5.35) for specific advice on programming the test

10.2.17 for test accuracy specification

7.31. WATT - Wattage

Where Used

The Wattage test is a measure of the input power required to energize a transformer at no load.

A Wattage test is an excellent check on the magnetic quality of the iron core and the magnetic joints and would typically be used with iron core transformers with an operating frequency of around 50Hz.

The test measures all losses caused by eddy currents in the core, hysteresis losses in the core and by the DC resistance of the winding being tested.

It should be noted that if you deploy the WATT test after a MAGI and VOC test, using the same V/F/Nodes then you will pay no time penalty for the test as the measurements are already made by the preceding two tests.

Measurement Conditions

During the Wattage test, a constant, user specified AC voltage is applied across the winding in question. All other windings are held open circuit during this test.

The AT5600 measures the voltage across and current through the winding. The Wattage is the product of the in-phase components of the current and voltage.

If, in the program, the WATT test follows either a VOC or MAGI test which has the same test conditions (voltage and frequency), and is applied to the same winding, then the measurement results from the previous tests can be re-used, saving program execution time.

The test signal can have a frequency in the range 20Hz to 1.5KHz, and an amplitude from 1V to 270V, and a power of up to 25W.

Please also see

AT dotNET Editor manual (98-125 2.5.39) for specific advice on programming the test

10.2.15 for test accuracy specification

7.32. WATX - Wattage (External Source)

Where Used

The Wattage test measures the power needed to energize a winding, usually the primary, with the remaining windings open circuit. It is usual to configure the test signal to the normal operating conditions of the transformer to determine the power needed to energize the transformer.

This test uses an external source to provide the test signal which must be coupled to the tester via a Voltech AC Source Interface (contact your supplier for details). See the AC Source Interface user manual or the Editor help system for details of how to configure external AC sources for use with an AT5600.

This test is suitable for line frequency transformers (25-400Hz) and checks the no-load losses in the transformer.

Measurement Conditions

During the Wattage (External Source) test, a constant, user specified AC voltage from an external source is applied across the winding in question. All other windings are held open circuit during this test.

The AT5600 measures the voltage across and current through the winding. The Wattage is the product of the in-phase components of the current and voltage.

If, in the program, the WATX test follows either a VOCX or MAGX test which has the same test conditions (voltage and frequency), and is applied to the same winding, then the measurement results from the previous tests can be re-used, saving program execution time.

The test signal can have a frequency in the range 20Hz to 5KHz, and an amplitude from 5V to 600V depending on the type of external source used. The current rating of a single AC Source Interface is 10A RMS. See also the WATT test which uses the AT5600s internal generator which can provide up to 270V AC at 25W.

Trimming of requested Voltage (when using Step-up transformer with AC Interface)

When using the AC interface with a step-up transformer, the AT5600 uses the Class D drive (used on VOC MAGI WATT and STRW) and routes it through the AC interface. The AT5600 calculates a nominal value for the voltage needed to get the target value based on your requested voltage, and the programmed ratio of your chosen transformer. The AT5600 will then attempt to trim to get the exact value that is needed.

If either of the following two conditions are exceeded, the AT will report a trimming failure (0020):

If the trimming requires deviation of more than 60% from the nominal (i.e., 100V nominal, but trimming requires excess of 160 V or less than 40 V)

If the trimming requires outputting more than 230

Please also see

AT dotNET Editor manual (98-125 2.5.46) for specific advice on programming the test and

10.2.16 for test accuracy specification

7.33. STRW – Stress Watts

Where Used

The Stress Wattage test tests the transformer for breakdown of insulation by measurement of the energizing power of a winding, usually the primary, with the remaining windings open circuit. This test applies the voltage, usually twice the normal operating voltage, over a chosen time (unlike the WATT test), and continually measures the power to determine any breakdown by changes in the measurement.

This test is suitable for sub-miniature line frequency, large line frequency bobbin wound and some HF transformers. It checks the integrity of inter-turn insulation, the magnetic material, and joints.

Measurement Conditions

A constant voltage source is applied to the winding under test. Both the RMS voltage and the power are measured. If necessary, the voltage can be trimmed to the user specified value, and the measurement repeated. The measurement is repeated many times until the dwell time has elapsed. The result given is the measured power.

Usually, the test conditions should be twice the working voltage and frequency and has the purpose of trying to create an inter-turn breakdown at a point of potential weakness in the wire enamel. This breakdown is detected by an increase in the measured power.

Note: Maximum power for this test is 25W

Please also see

AT dotNET Editor manual (98-125 2.5.40) for specific advice on programming the test

10.2.15 for test accuracy specification

7.34. STRX – Stress Watts (External Source)

Where Used

The Stress Watts (External Source) test tests the transformer for breakdown of winding insulation by measurement of the energizing power of a winding, usually the primary, with the remaining windings open circuit. This test applies the voltage from an external AC source (usually at twice the normal operating voltage and frequency), and measures the power drawn.

This test uses an external source to provide the test signal which must be coupled to the tester via a Voltech AC Source Interface (contact your supplier for details). See the AC Source Interface user manual or the Editor Help system for details of how to configure external AC sources for use with an AT5600. This test is suitable for large line frequency bobbin wound and some HF transformers. It checks the integrity of inter-turn insulation, the magnetic material, and joints at higher than the normal operating voltage.

Measurements Conditions

A constant voltage (supplied by an external source) is applied to the winding under test. Both the RMS voltage and the power are measured. If necessary (and depending on the source type used), the voltage can be trimmed to the user specified value, and the measurement repeated. The measurement is repeated many times until the dwell time has elapsed. The result given is the measured power.

The test can detect winding insulation defects in the following way:

- The winding insulation is stressed using the increased voltage (increased volts per turn).
- Increasing the frequency in proportion to the voltage increase ensures that the magnetic core of the transformer is exercised over the same area as it would be at the normal operating voltage and frequency. - The core losses remain the same.
- A significant increase in the power drawn when tested at increased voltage and frequency indicates a failure of the winding insulation that would not be detected at normal operating conditions.

The test signal can have a frequency in the range 20Hz to 5KHz, and an amplitude from 5V to 600V depending on the type of external source used. The current rating of a single AC Source Interface is 10A RMS. See also the STRW test which uses the AT5600s internal generator which can provide up to 270V AC at 25W.

Trimming of requested Voltage (when using Step-up transformer with AC Interface)

When using the AC interface with a step-up transformer, the AT5600 uses the Class D drive (used on VOC MAGI WATT and STRW) and routes it through the AC interface. The AT5600 calculates a nominal value for the voltage needed to get the target value based on your requested voltage, and the programmed ratio of your chosen transformer. The AT5600 will then attempt to trim to get the exact value that is needed.

If either of the following two conditions are exceeded, the AT will report a trimming failure (0020):

If the trimming requires deviation of more than 60% from the nominal (i.e., 100V nominal, but trimming requires excess of 160 V or less than 40 V)

If the trimming requires outputting more than 230

Please also see

AT dotNET Editor manual (98-125 2.5.47) for specific advice on programming the test and

10.2.16 for test accuracy specification

7.35. MAGI - Magnetizing Current

Where Used

The AT5600 offers two basic alternative ways to confirm that the transformer has been assembled properly, with the appropriate number of primary and secondary turns, the right grade of magnetic material for the core, and the correct air gap if required.

Magnetizing current and open circuit voltage are the preferred tests for line frequency transformers, designed to operate over the full extent of the B-H curve, including the non-linear regions. These allow you to test operation at the intended voltage and frequency, rather than trying to understand the performance by using conventional 5v LCR style tests.

(For other transformers, such as pulse transformers and those used in switched mode power supplies, inductance and turns ratio are the preferred tests.)

Measurement Conditions

When measuring magnetizing current, you should normally program the test to apply the highest working voltage at the lowest working frequency to the primary winding.

In the case of a transformer with a split primary the test can be conducted equally well by energizing just one of the primary windings, as opposed to the two in series. The expected current will be greater for the single winding, rising in proportion to the turns ratio:

$$I_A = I_{AB} \times (N_{AB} / N_A)$$

where

I_A = The current to be specified when testing with winding A

I_{AB} = The current for windings A and B in series

N_A = The number of turns on winding A

N_{AB} = The number of turns on A and B in series

(As an alternative, the formula above can be written using the voltage ratio between the two windings, rather than the turns ratio.)

In principle, you may measure the magnetizing current using any winding, or any series combination of windings, with the current limit adjusted according to the formula above, because the Ampere-turns required to magnetize a transformer to a given flux level is independent of which winding is used.

In practice, the magnetizing current waveform may have a transient component following the switch-on of the test voltage, which is the inrush effect.

To give you repeatable and accurate results, the measurement does not start until any transient has settled.

In addition, to give you the quickest test execution time, the AT5600 uses an intelligent switch-on sequence which minimizes such transient effects and gets the transformer to steady operating conditions much faster.

Specifying the Test Limits

The AT5600 offers you two ways to specify the test limits:

- Using a true RMS measurement (the most common method)
- Using a mean-sense measurement that is scaled to RMS for sine waves.

However, you may wish to use the second method if, for example, your test limits have been established by a previous measurement on a low-cost multi-meter which uses this technique.

Please also see
AT dotNET Editor manual (98-125 2.5.37) for specific advice on programming the
test
10.2.6 for test accuracy specification

7.36. MAGX - Magnetizing Current (External Source)

Where Used

The AT5600 offers two basic alternative ways to confirm that the transformer has been assembled properly, with the appropriate number of primary and secondary turns, the right grade of magnetic material for the core, and the correct air gap if required.

Magnetizing current and open circuit voltage are the preferred tests for line frequency transformers, designed to operate over the full extent of the B-H curve, including the non-linear regions.

(For other transformers, such as pulse transformers and those used in switched mode power supplies, inductance and turns ratio are the preferred tests.)

This version of the MAGI test uses an external source to provide the test signal which must be coupled to the tester via a Voltech AC Source Interface (contact your supplier for details). See the AC Source Interface user manual or the Editor help system for details of how to configure external AC sources for use with an AT5600.

Measurement Conditions

When measuring magnetizing current, you should normally program the test to apply the highest working voltage at the lowest working frequency to the primary winding.

In the case of a transformer with a split primary, the test can be conducted equally well by energizing just one of the primary windings, as opposed to the two in series. The expected current will be greater for the single winding, rising in proportion to the turns ratio:

$$I_A = I_{AB} \times (N_{AB} / N_A)$$

where?

I_A = The current to be specified when testing with winding A

I_{AB} = The current for windings A and B in series

N_A = The number of turns on winding A

N_{AB} = The number of turns on A and B in series

(As an alternative, the formula above can be written using the voltage ratio between the two windings, rather than the turns ratio.)

In principle, you may measure the magnetizing current using any winding, or any series combination of windings, with the current limit adjusted according to the formula above, because the Ampere-turns required to magnetize a transformer to a given flux level is independent of which winding is used.

In practice, the magnetizing current waveform may have a transient component following the switch-on of the test voltage. To give you repeatable accurate results, the measurement does not start until any transient has settled.

The test signal can have a frequency in the range 20 Hz to 5 kHz, and an amplitude from 5V to 600V depending on the type of external source used. The current rating of a single AC Source Interface is 10A RMS. See also the MAGI test which uses the AT5600s internal generator which can provide up to 270V AC at 25W.

Trimming of requested Voltage (when using Step-up transformer with AC Interface)

When using the AC interface with a step-up transformer, the AT5600 uses the Class D drive (used on VOC MAGI WATT and STRW) and routes it through the AC interface. The AT5600 calculates a nominal value for the voltage needed to get the target value based on your requested voltage, and the programmed ratio of your chosen transformer. The AT5600 will then attempt to trim to get the exact value that is needed.

If either of the following two conditions are exceeded, the AT will report a trimming failure (0020):

If the trimming requires deviation of more than 60% from the nominal (i.e., 100V nominal, but trimming requires excess of 160 V or less than 40 V)

If the trimming requires outputting more than 230

Please also see
AT dotNET Editor manual (98-125 2.5.44) for specific advice on programming the test and
10.2.7 for test accuracy specification

7.37. VOC - Open Circuit Voltage

Where Used

The AT5600 offers two basic alternative ways to confirm that the transformer has been assembled properly, with the appropriate number of primary and secondary turns.

Open circuit voltage measurements are the preferred tests for line frequency transformers, designed to operate over the full extent of the B-H curve, including the non-linear regions. VOC is preferable over TR, as it allows you to measure the performance under real operating conditions, where you are at the limit of the B-H curve.

For other transformers, such as pulse transformers and those used in switched mode power supplies, a measurement of turns ratio is the preferred test.

Clearly an open circuit voltage test cannot tell you the actual number of turns on a winding, only the ratio between one winding and the next. You should therefore also include a magnetizing current test in your program to give confidence that the absolute number of turns is correct as well as the ratio.

Measurement Conditions

Open circuit voltage is measured by applying an AC test voltage to a selected winding (usually a primary winding), and measuring the resulting voltage produced on another winding.

If, there are several windings to be tested, the program will execute more quickly if the following points are observed:

Place all the open circuit voltage (VOC) tests consecutively at the same point in the program.

Use the same energized winding, with the same test voltage and frequency for each test.

If there is a magnetizing current (MAGI) test which has the same energized winding and the same test voltage and frequency, place this immediately before the first open circuit voltage test.

Specifying the Test Limits

The AT5600 offers you three ways to specify the test limits:

Using a normal AC (RMS) measurement.

Using a rectified (mean) measurement.

Using a DC (mean) measurement.

The AC (RMS) value would be used, but you could use the rectified (mean) or DC (mean) measurements if, for example, you are testing transformers fitted with a rectifying diode.

To give the best accuracy, the DC measurement is averaged over the period of the test frequency.

In addition, the VOC test can be used to test the polarity (or phasing) of the windings, if this is required.

VOC using Constant Current

The VOC test also allows you to specify a constant target current rather than a Voltage as you specified test conditions.

In this case the AT EDITOR dialog box will ask for a Nominal Voltage.

The AT uses this nominal voltage as a starting position for testing. The AT5600 will then attempt to trim V to get the exact value current that is needed.

If either of the following two conditions are exceeded, the AT will report a trimming failure (0020):

If the trimming requires deviation of more than 60% from the nominal (i.e., 100V nominal, but trimming requires excess of 160 V or less than 40 V)

If the trimming requires outputting more than 270V.

Best Practice for Centre Taps / Autotransformers (applies to tests TR, LVOC, VOC, VOCX)

See 7.13 for best practice advice on minimising common mode effects when testing auto transformers or centre taps.

Please also see

AT dotNET Editor manual (98-125 2.5.38) for specific advice on programming the test and

10.2.8 for test accuracy specification

7.38. VOCX - O/C Voltage (External Source)

Where Used

The AT5600 offers two basic alternative ways to confirm that the transformer has been assembled properly, with the appropriate number of primary and secondary turns.

Open circuit voltage measurements are the preferred tests for line frequency transformers, designed to operate over the full extent of the B-H curve, including the non-linear regions.

(For other transformers, such as pulse transformers and those used in switched mode power supplies, a measurement of turns ratio is the preferred test.)

Clearly an open circuit voltage test cannot tell you the actual number of turns on a winding, only the ratio between one winding and the next. You should therefore also include a magnetizing current test (MAGI or MAGX) in your program, to give confidence that the absolute number of turns is correct as well as the ratio.

This version of the VOC test uses an external source to provide the test signal which must be coupled to the tester via a Voltech AC Source Interface (contact your supplier for details). See the AC Source Interface user manual or the Editor help system for details of how to configure external AC sources for use with an AT5600.

Measurement Conditions

Open circuit voltage is measured by applying an AC test voltage (supplied by an external source) to a selected winding (usually a primary winding), and measuring the resulting voltage produced on another winding.

If there are several windings to be tested, then the program will execute more quickly if the following points are observed:

- Place all the open circuit voltage (VOCX) tests consecutively at the same point in the program.
- Use the same energized winding, with the same test voltage and frequency for each test.
- If there is a magnetizing current (MAGX) test which has the same energized winding and the same test voltage and frequency, place this immediately before the first open circuit voltage test.

The test signal can have a frequency in the range 20Hz to 5 kHz, and an amplitude from 5V to 600V depending on the type of external source used. The current rating of a single AC Source Interface is 10A RMS. See also the MAGI test which uses the AT5600s internal generator which can provide up to 270V AC at 25W.

Specifying the Test Limits

The AT5600 offers you three ways to specify the test limits:

- Using a normal AC (RMS) measurement.
- Using a rectified (mean) measurement.
- Using a DC (mean) measurement.

The AC (RMS) value would be used, but you could use the rectified (mean) or DC (mean) measurements if, for example, you are testing transformers fitted with a rectifying diode.

To give the best accuracy, the DC measurement is averaged over the period of the energizing frequency. In addition, the VOCX test can be used to test the polarity (or phasing) of the windings, if this is required. This is not available when some types of external source.

Trimming of requested Voltage (when using Step-up transformer with AC Interface)

When using the AC interface with a step-up transformer, the AT5600 uses the Class D drive (used on VOC MAGI WATT and STRW) and routes it through the AC interface. The AT5600 calculates a nominal value for the voltage needed to get the target value based on your requested voltage, and the programmed ratio of your chosen transformer. The AT5600 will then attempt to trim to get the exact value that is needed.

If either of the following two conditions are exceeded, the AT will report a trimming failure (0020):

If the trimming requires deviation of more than 60% from the nominal (i.e., 100V nominal, but trimming requires excess of 160 V or less than 40 V)

If the trimming requires outputting more than 230 V

Best Practice for Centre Taps / Autotransformers (applies to tests TR, LVOC, VOC, VOCX)

See 7.13 for best practice advice on minimising common mode effects when testing auto transformers or centre taps.

Please also see

AT dotNET Editor manual (98-125 2.5.45) for specific advice on programming the test and

10.2.9 for test accuracy specification

7.39. LVOC – Low Voltage Open Circuit

Measurement Range	Test Voltage	Test Frequency	Basic Accuracy
100 μ V to 650V	1mV to 5V	20Hz to 3MHz	0.10%

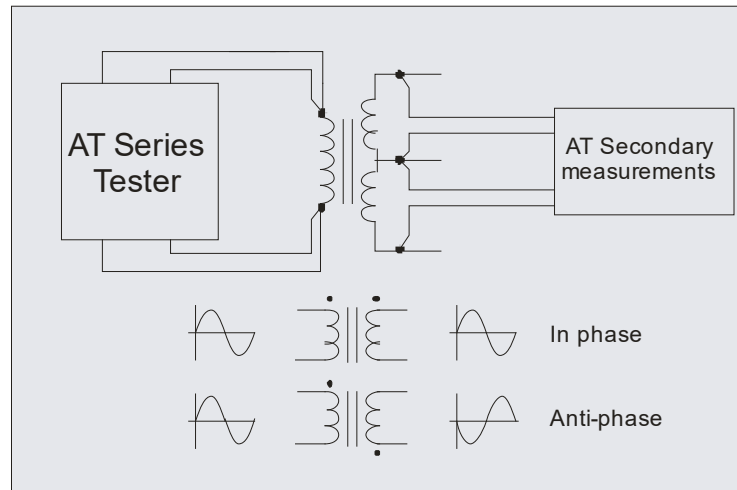

Where used.

The low voltage open circuit test is used to confirm that windings have the correct ratio of turns between them, and that the phasing of the windings is correct. This test is used for signal, pulse, and switched mode power transformers where the normal operating conditions require only small excursions of the B-H curve, never extending beyond the linear region. On the AT5600, high voltage open circuit tests (VOC or VOCX) are available for testing line frequency transformers at their operating point (up to 270V, 1 kHz and 2A). To measure the voltage ratio rather than the voltage, see the test TR – turns ratio.

Measurement conditions

To measure low voltage open circuit, the test signal is applied to one winding called the energized winding. The voltages across another winding (or the same, energized winding) are measured. The low voltage open circuit measurement is the RMS value of the voltage measured and can be an AC or a DC voltage. It is recommended that you choose the winding with the highest number of turns as the one to be energized.

Choosing test conditions

The recommended test conditions depend on the inductance of the energized winding; they are given in the table below assuming that the energized winding is the one with the highest number of turns:

Inductance of the Energized Winding			Preferred test signal	
			Frequency	Voltage
100nH	→	1μH	300kHz	10mV
1uH	→	10μH	100kHz	30mV
10uH	→	100μH	30kHz	50mV
100uH	→	1mH	10kHz	100mV
1mH	→	10mH	1kHz	100mV
10mH	→	100mH	100Hz	100mV
100mH	→	1H	100Hz	300mV
1H	→	10H	50Hz	1V
10H	→	100H	50Hz	5V
100H	→	1kH	50Hz	5V
1kH	→	10kH	20Hz	5V

V Applied and V measured

The signal is usually applied to the primary winding, or the winding which has the largest number of turns.

However, if by doing this, the expected voltage on the winding with the smallest number of turns falls below 1mV, then the test voltage should be increased. **Best repeatable measurements will be obtained ONLY if both the V applied, and V measured are BOTH >1mV.**

This may also require an increase in the test frequency so that the current taken by the driven winding does not become too large, but in general this frequency increase should be kept as small as possible to avoid problems caused by stray capacitance at high frequencies.

Best Practice for Centre Taps / Autotransformers (applies to tests TR, LVOC, VOC, VOCX)

See 7.13 for best practice advice on minimising common mode effects when testing auto transformers or centre taps.

Please also see
AT dotNET Editor manual (98-125 2.5.29) for specific advice on programming the test
10.2.10 for test accuracy specification

7.40. ILK – Leakage Current

Where Used

The leakage current test is needed for transformers used in certain applications, mainly medical, where it is an additional safety requirement.

It provides a measure of leakage current caused by real world inter-winding capacitance between the chosen windings under test. In medical uses even currents as low as 100 uA may be considered dangerous, hence this is an important test requirement.

Even in non-medical applications, leakage current can affect the isolated side of measurement equipment so can be useful test in instrumentation transformers.

Whilst a traditional C test would tell you the interwinding capacitance, this would only be at 5V, not operating voltages. Medical standards also demand real measurement of the actual current, not the capacitance.

Measurement Conditions

The test is typically carried out by applying the test voltage between all the primary terminals shorted together, and all the secondary terminals and screen shorted together.

The voltage and frequency applied are normally the operating voltage and frequency of the transformer.

The energisation voltage can be 0-270V , 20-1500 Hz.

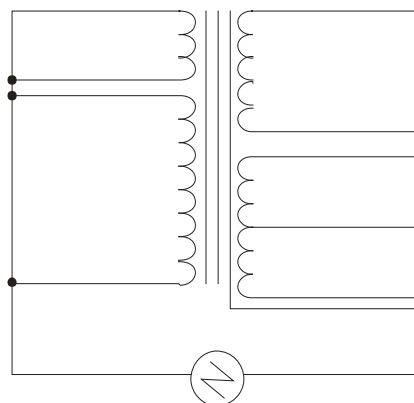

Please also see

AT dotNET Editor manual (98-125 2.5.36) for specific advice on programming the test

10.2.26 for test accuracy specification

7.41. LSBX – Inductance with External Bias (Series Circuit)

DC Bias	Measure Range	Test Voltage	Test Frequency	Basic Accuracy
0.1A to 250A	1nH 1MH	1mV to 5V	20Hz to 3MHz	0.2% @ Q>10

This test requires the use of one or more Voltech DC1000 Precision DC Bias Current Sources.

IMPORTANT; When using this test, ensure that the terminal you pick as HIGH in the editor program is also the node that is connected to the AHi output of the DC1000. Similarly, the node you specify as LOW should also be the node that is connected to the ALo output of the DC1000.

The inductance of a transformer winding while an external bias current is flowing through it may be tested using series or parallel equivalent circuit models.

Initially the DC bias current is set up and allowed to stabilize.

An AC voltage is applied across the selected winding; the voltage across and current through the winding is then measured using harmonic analysis. The measured voltage is divided by the current to obtain a complex impedance and the inductance is calculated.

IMPORTANT UPDATE FOR LEGACY AT3600 USERS

The DC1000 can be easily integrated with the AT series testers to give automated and integrated DC Bias testing, combined with the wide range of tests provided by the AT Series.

If you are integrating the DC1000 with any of the high voltage AT tests (IR, HPAC, HPDC,) it is important that the DC1000 is ONLY connected to nodes used as the LO terminals in these high voltage tests. This will prevent damage to the DC1000.

Any terminals used for LSBX, LPBX & ZBX, **cannot** be used as “HI” terminals for IR HPAC, HPDC, in the same program.

The AT5600 and AT Editor will check for this and warn you if you are attempting to do this. The AT3600 and old AT Editor did not give this warning, but it is still a valid best practice for the AT3600. See DC1000A user manual section 6.5.4

Please also see

AT dotNET Editor manual (98-125 2.5.41) for specific advice on programming the test

10.2.27 for test accuracy specification

7.42. LPBX – Inductance with External Bias (Parallel Circuit)

DC Bias	Measure Range	Test Voltage	Test Frequency	Basic Accuracy
0.1A to 250A	1nH 1MH	1mV to 5V	20Hz to 3MHz	0.2% @ Q>10

This test requires the use of one or more Voltech DC1000 Precision DC Bias Current Sources.

IMPORTANT; When using this test, ensure that the terminal you pick as HIGH in the editor program is also the node that is connected to the AHi output of the DC1000. Similarly, the node you specify as LOW should also be the node that is connected to the ALo output of the DC1000.

The inductance of a transformer winding while an external bias current is flowing through it may be tested using series or parallel equivalent circuit models.

Initially the DC bias current is set up and allowed to stabilize.

An AC voltage is applied across the selected winding; the voltage across and current through the winding are then measured using harmonic analysis.

The measured voltage is divided by the current to obtain complex impedance and the inductance is calculated.

IMPORTANT UPDATE FOR LEGACY AT3600 USERS

The DC1000 can be easily integrated with the AT series testers to give automated and integrated DC Bias testing, combined with the wide range of tests provided by the AT Series.

If you are integrating the DC1000 with any of the high voltage AT tests (IR, HPAC, HPDC,) it is important that the DC1000 is ONLY connected to nodes used as the LO terminals in these high voltage tests. This will prevent damage to the DC1000.

Any terminals used for LSBX, LPBX & ZBX, **cannot** be used as "HI" terminals for IR HPAC, HPDC, in the same program.

The AT5600 and AT Editor will check for this and warn you if you are attempting to do this. The AT3600 and old AT Editor did not give this warning, but it is still a valid best practice for the AT3600. See DC1000A user manual section 6.5.4

Please also see

AT dotNET Editor manual (98-125 2.5.42) for specific advice on programming the test

10.2.27 for test accuracy specification

7.43. ZBX - Impedance with External Bias

DC Bias	Measure Range	Test Voltage	Test Frequency	Basic Accuracy
0.1A to 250A	1mΩ to 1MΩ	1mV to 5V	20Hz to 3MHz	0.2%

This test requires the use of one or more Voltech DC1000 Precision DC Bias Current Sources.

IMPORTANT; When using this test, ensure that the terminal you pick as HIGH in the editor program is also the node that is connected to the AHi output of the DC1000. Similarly, the node you specify as LOW should also be the node that is connected to the ALo output of the DC1000.

The Winding Impedance with External Bias test measures the impedance of a selected winding while applying a DC current from the DC1000 through the winding. An AC voltage is also applied across the winding from the AT.

This test can be used with inductors to measure the change in impedance with a bias current.

IMPORTANT UPDATE FOR LEGACY AT3600 USERS

The DC1000 can be easily integrated with the AT series testers to give automated and integrated DC Bias testing, combined with the wide range of tests provided by the AT Series.

If you are integrating the DC1000 with any of the high voltage AT tests (IR, HPAC, HPDC,) it is important that the DC1000 is ONLY connected to nodes used as the LO terminals in these high voltage tests. This will prevent damage to the DC1000.

Any terminals used for LSBX, LPBX & ZBX, **cannot** be used as "HI" terminals for IR HPAC, HPDC in the same program.

The AT5600 and AT Editor will check for this and warn you if you are attempting to do this. The AT3600 and old AT Editor did not give this warning, but it is still a valid best practice for the AT3600. See DC1000A user manual section 6.5.4

Please also see
AT dotNET Editor manual (98-125 2.5.43) for specific advice on programming the test
10.2.28 for test accuracy specification

7.44. ACRT - AC HI-POT Ramp

This test has been withdrawn and is no longer supported

7.45. DCRT - DC HI-POT Ramp

This test has been withdrawn and is no longer supported

7.46. ACVB - AC Voltage Break Down

This test has been withdrawn and is no longer supported.

7.47. DCVB - DC Voltage Break Down

This test has been withdrawn and is no longer supported

7.48. WAIT – Fixed duration or Indefinite Test Delay

Where Used

The WAIT test can be used in two main ways to give greater control over the timing of the test program execution.

1, Fixed Duration Delay

To allow a fixed duration to pause during a test program.

Possible use cases

To allow time for the UUT to demagnetise after a high voltage or high bias test before proceeding with the rest of the test in a program.

To allow a fixed time for external apparatus (e.g., your own external hydraulic or pneumatic systems) to operate

To allow any relays operated by an OUT (User Port) test to settle and stabilize, if you find that the speed of execution is too rapid to allow for such devices to settle into their switched state.

The programmed delay can be 1 milli second to 60 Seconds.

Once the requested time has elapsed the program test sequence is automatically resumed.

During the delay time the interlock is still active and a break to the interlock will result in a controlled program halt as normal.

2, Wait for User

To allow an infinite to wait to the program sequence to allow the operator to make changes to wiring before allowing the program to resume execution.

Possible use cases

To allow the operator to add (or then later to remove) a load resistor or other component from the UUT.

To allow any change to wiring configuration, either manually or by switches / relays to be implemented manually.

This mode allows users to

A, implement a semi-automatic switching process where the volume of parts being tested may not make it cost effective to build a fully automatic switching fixture using the OUT test.

B, perform proof-of-concept testing on small volume prototype batches before financially committing to a fixture using the OUT test to switch relays.

In this case the AT5600 interlock is deactivated once all signals are confirmed to be OFF, to then allow the user to touch the UUT to make amendments to the UUT.

Once the user presses RUN to continue, the interlock is re-enabled to ensure user safety, and the test program is resumed.

Most importantly, this allows you to make configuration changes during a test program so that the full test sequence is still recorded as one set of results.

Specifying Test Conditions

Wait settings.

In the AT Editor inset the WAIT test where you would like the pause to occur

Then either

A Select DURATION for a fixed duration and enter the duration of the pause. This can be 0.001 - 60.000 Seconds.

B, Select Wait for User to request a halt to the program until the user restarts by using the RUN button.

7.49. PWRF – Power Factor Test

What is Power Factor

Power factor is defined as the ratio of real to apparent power used in any circuit.

Electrically it is defined as

$$\text{Power Factor} = [\text{Real Power} / \text{Apparent Power}] = [\text{Watts} / (\text{Volts} \times \text{Amps})]$$

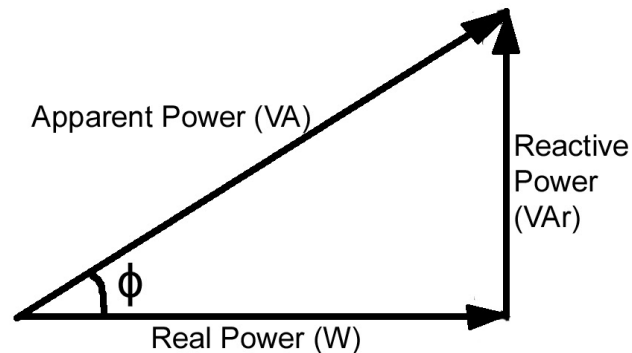

As can be seen from the above vector diagram,

$$\text{COS}(\phi) = \text{Power Factor}$$

Theoretically, power factor can range from -1 to +1. (Negative power factors indicate energy being returned from the load.)

In the case of a passive transformer, this PF will usually be between 0 and 1, with the ideal being a power factor of 1.

The AT5600 allows you to make a direct measurement of this important parameter in two ways.

1, True Power factor

This includes the fundamental and all harmonic content of Volts and Amps and Watts

2, Displacement Power Factor

This measures only the fundamentals of Volts and Amps and Watts

There is a third term "Distortion Power Factor," that is only of the harmonic content, but this is rarely used as it carries little meaning in practical applications.

It can also be easily calculated from

$$\text{True PF} = \text{Displacement PF} * \text{Distortion PF}$$

Where Used

The PWRF test can be used on any transformer but is most applicable to any mains / line voltage transformer where external standards and regulations require transformers used on equipment to be efficient and not lossy.

Low power factors indicate an inefficient use of energy that could result in thermal heating of windings and cores , resulting in lower life spans, as well as the obvious financial operating cost of the electrical power lost.

PWRF is also important for current transformers, where an ideal CT would have no winding resistance, no magnetising current on the winding and no core losses, all of which will result in measurement error.

The PWRF test provides a convenient single test for confirming integrity of complete products - i.e., Core material consistency, DC Resistance and Magnetizing current.

Measurement Conditions

During the Power Factor test, a constant, user specified AC voltage is applied across a selected winding.

All other windings are held open circuit during this test.

The AT5600 measures the voltage across the winding and current through the winding.

The Wattage is also measured as the product of the current and voltage waveforms.

If, in the program, the PWRF test follows either a VOC or MAG or WATT test which has the same test conditions (voltage and frequency), and is applied to the same winding, then the measurement results from the previous tests will be reused, saving on program execution time.

The test signal can have a frequency in the range 20Hz to 1.5KHz, and an amplitude from 1V to 270V, and a power of up to 25W.

8. Front Panel Operation

8.1. Introduction

8.1.1. The Touch Screen Display

The AT5600 has a colour touch screen display. Light finger pressure will activate any touch sensitive area.

The format of the screen display is similar throughout the menu system and consists of a screen title at the top, a main window on the left, and a soft-key area on the right.

Each of the soft-keys changes function depending on the active menu.

The current functionality is displayed within the soft-key border by some text or a symbol. This is also referred to as the soft-key name. There are up to 5 soft-keys on any screen.

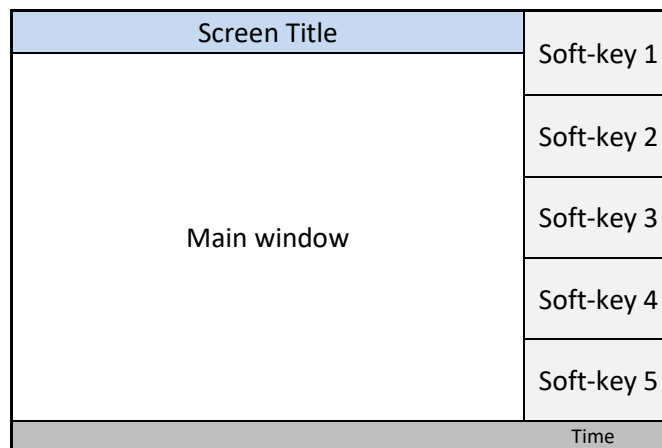

8.1.2. RUN and STOP buttons.

The run and stop buttons are high sensitivity Piezo switches that need light pressure to activate while moving an unperceivable amount.

This minimizes operator fatigue and provides extremely high switch reliability.

Each button is also surrounded by an indicator – green for RUN and red for STOP.

The green indicator will light while a test program is running and the red indicator when it has been stopped.

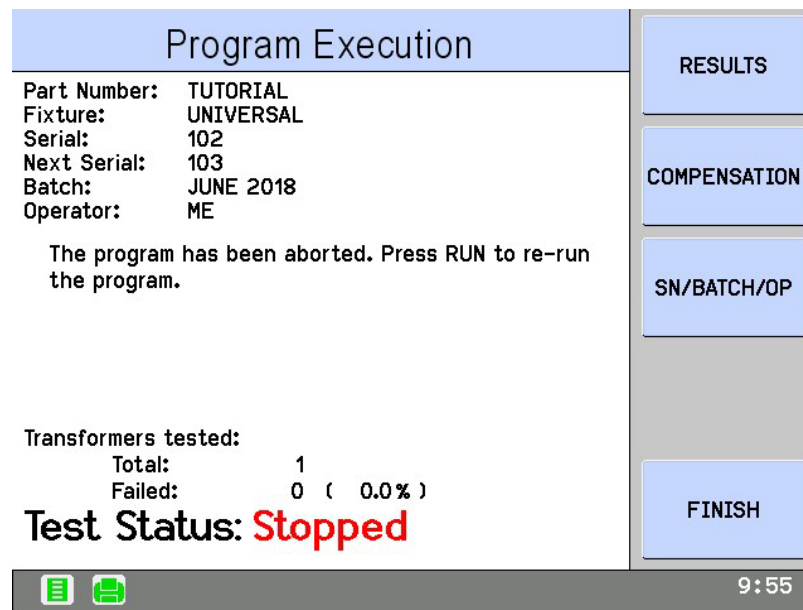

8.1.3. User Input

User input can be made into the AT5600 using the touch screen, buttons, or other accessories connected to available interface ports.

The touch screen provides the ability to tap and select items, and to display a soft keyboard for typing.

A foot switch or other control device can be connected to the remote port.

8.1.4. Splash Screen

When the AT5600 is switched on, for a brief time a splash screen shall be displayed while the AT5600 performs some internal checks and initializes its operating system.



8.1.5. Power On

Once the AT5600 has initialized and powered up, it will wait for user input. This is the top-level menu for access to all the major functions available.

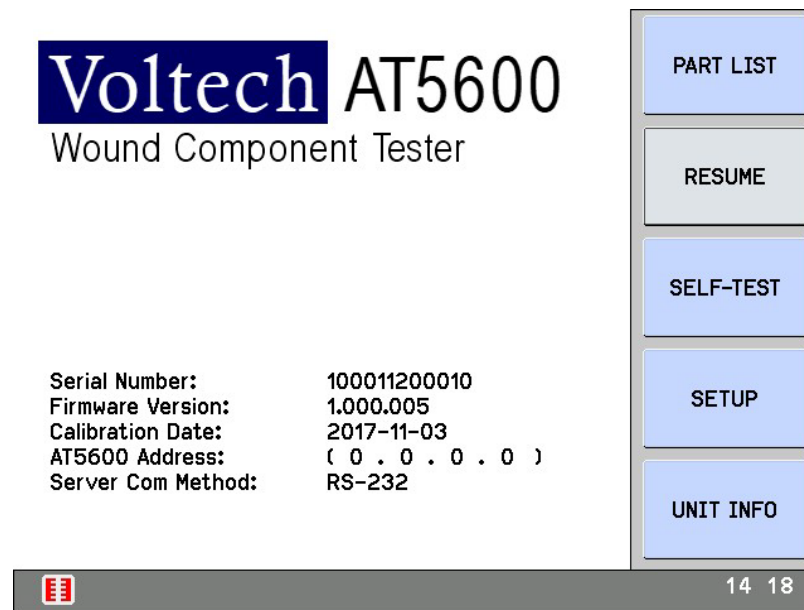

- | | |
|-----------|---|
| PART LIST | Load a test program from AT SERVER software |
| RESUME | re-load the last test program if "FINISH"-ed accidentally |
| SELF-TEST | checks the internal functionality of the AT5600 |
| SET UP | changes the AT5600 options |
| UNIT INFO | Information on the AT5600 |

8.1.6. PART LIST

This is the normal operating mode of the AT5600 when used for production testing of transformers.

Before you try to use the tester in EXECUTE Mode, make sure that all the following have been carried out:

- Test programs have been created for the transformers you wish to test.
- The programs are stored in the AT Server, which is connected to the tester and running, and the tester has been set up to use the Server via either ETHERNET or RS232
- Fixtures have been created for the transformers you wish to test.

To access EXECUTE Mode, from the top-level menu, tap the soft-key PART LIST to change to the following display:

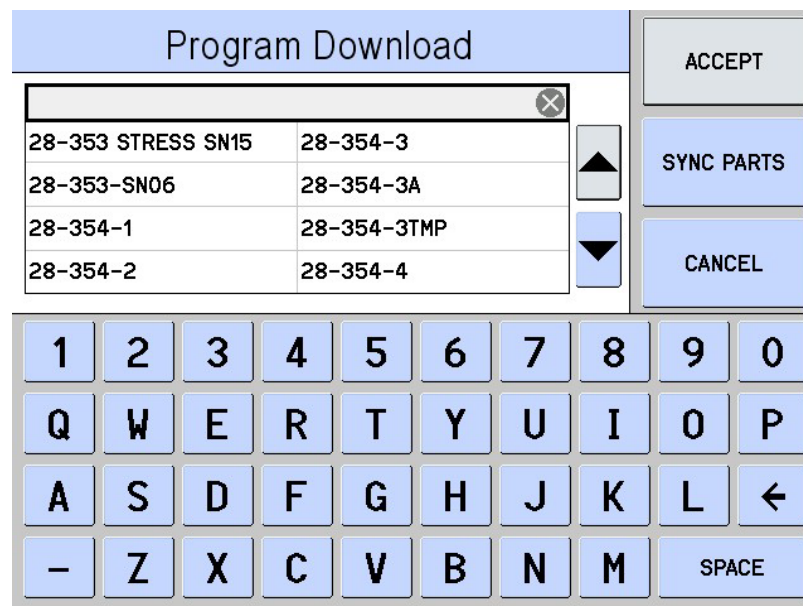

- ACCEPT – to load the selected test program.
- BACKSPACE - clears the last character entered.
- PAGE UP – Page up the list of programs
- PAGE DOWN – Page down the list of programs
- CANCEL – return to the top-level screen.
- SYNC P/N LIST – Gets a fresh list of programs from the AT Server. This list (but NOT the actual program) is stored in the AT5600 so only needs SYNC if the list changes. This speeds up navigation. The actual ATP test program will always be fetched from the Server, never stored in the unit.

8.1.6.1 Entering a Part Number

The 2 x 4 grid shows all the test programs stored in your AT SERVER programs directory folder.

This folder could be on the AT SERVER PC or on a network drive connected to the AT SERVER PC

Select the program from the list by using page up and down and clicking directly on the test program name. This will move it into the top grey selection box.

Using the keyboard will filter the list of program names to match your entry as shown below.

The screenshot shows a 'Program Download' window. At the top, there is a search filter box containing 'TUT' with a clear 'X' button. Below the filter is a list of programs: 'TUTORIAL' and 'TUTORIAL2'. To the right of the list are up and down arrow buttons. To the right of the list are three buttons: 'ACCEPT', 'SYNC PARTS', and 'CANCEL'. Below the list is a virtual keyboard with the following layout:

1	2	3	4	5	6	7	8	9	0
Q	W	E	R	T	Y	U	I	O	P
A	S	D	F	G	H	J	K	L	←
-	Z	X	C	V	B	N	M	SPACE	

The program name can be typed (or partially typed) at the keyboard or selected from the list.

Tap the soft key ACCEPT when program is selected.

You can clear any selection by clicking on the "X" to the right of the selection box.

As stated in Chapter 3 'The test program editor', test programs (*.ATP) may be created with the following three options enabled or disabled:

- Serial numbers
- Batch number
- Operator name

In each case, if the option is enabled, the data entered by the operator for that option is included with the results which are sent back to the server.

This additional data is then available to be used as you wish; for example, it may be included in your production reports.

Note that these options are part of the program, not global settings for the AT, allowing you to enable different options for each transformer as required.

If you have chosen to enable any of these, then on program load, the following screen will be shown.

8.1.6.2 Serial Number

You may enter the Serial Number of the transformer, if applicable.

Tap the SERIAL NUMBER soft key; you will see the following display:

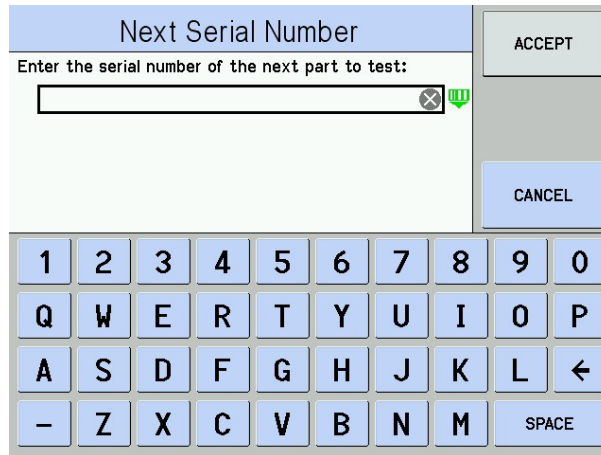

Enter the serial number for the transformer under test then tap the ACCEPT key.

The GREEN ICON indicates that this field will accept an entry from a BARCODE READER

The BACKSPACE (<-) soft key will clear the last character entered.

The “X” in the entry field will clear the whole text.

Serial numbers can be alphanumeric, and the tester will auto increment the last numeric digits after each run.

Remember to create enough leading zeros, if you are going to exceed the number of digits – see examples below.

100	101	102	103	etc.
ATY678	ATY679	ATY680	ATY681	etc.
RFR998	RFR999	RFR000	RFR001	etc.
RFR0998	RFR0999	RFR1000	RFR1001	etc.

Valid Characters for Serial / Operator / Batch

The barcode or USB keyboard input can only recognise the same characters as those that could be entered by the manual front panel keyboard method.

These are

- 0-9 Numerals
- A-Z Uppercase Characters ONLY
- “-“ Minus symbol
- “ “ Space.

8.1.6.3 Batch

You may enter the Batch Number of the transformer, if applicable,

Tap the BATCH/ soft key; you will see the following display:

The screenshot shows a software interface for entering a batch number. At the top, there is a blue header bar with the text 'Batch Number'. Below this, a subtitle reads 'Enter the batch number that will be tested:'. Underneath the subtitle is a white text input field with a green barcode icon on its right side and a small 'X' icon on its left side. To the right of the input field are two buttons: 'ACCEPT' (top) and 'CANCEL' (bottom). Below the input field and buttons is a numeric keypad with letters Q-Z and a 'SPACE' key.

Enter the batch number for the transformer under test then tap the ACCEPT key.

The GREEN ICON indicates that this field will accept an entry from a BARCODE READER

The BACKSPACE (<-) key will clear the last character entered.

The "X" in the entry field will clear the whole text.

Valid Characters for Serial / Operator / Batch

The USB barcode or USB keyboard input can only recognise the same characters as those that could be entered by the manual front panel keyboard method.

These are

- 0-9 Numerals
- A-Z Uppercase Characters ONLY
- "-" Minus symbol
- " " Space

8.1.6.4 Operator

You may enter the Operator Name if applicable.

Tap the OPERATOR soft key; you will see the following display:

The screenshot shows a software interface for entering an operator name. At the top, there is a title bar labeled "Operator Name" and a subtitle "Enter the operator name that will perform the testing:". Below the subtitle is a text input field with a cursor, a clear button (X), and a green barcode reader icon. To the right of the input field are "ACCEPT" and "CANCEL" buttons. Below the input field is a numeric keypad with letters QWERTYUIOP, ASDFGHJKL, and ZXCVBNM, plus a space key.

Enter the OPERATOR NAME then tap the ACCEPT key.

The GREEN ICON indicates that this field will accept an entry from a BARCODE READER

The BACKSPACE (<-) key will clear the last character entered.

The "X" in the entry field will clear the whole text.

Valid Characters for Serial / Operator / Batch

The USB barcode or USB keyboard input can only recognise the same characters as those that could be entered by the manual front panel keyboard method.

These are

- 0-9 Numerals
- A-Z Uppercase Characters ONLY
- "-" Minus symbol
- " " Space

8.1.6.5 Compensation

Short-circuit, Open-circuit, and Load compensation can be performed to take account of fixture and cabling effects on measurement results.

This is optional (you may find that these effects are not critical to your measurement accuracy, if you have wide PASS/FAIL limits) but SC + OC should always be performed when possible. Load compensation is optional only on 2 tests and gives you the ability to normalize results to a known, measured standard part. **See section 13.5 for full details.**

On Program load, you are asked if you wish to apply compensation.

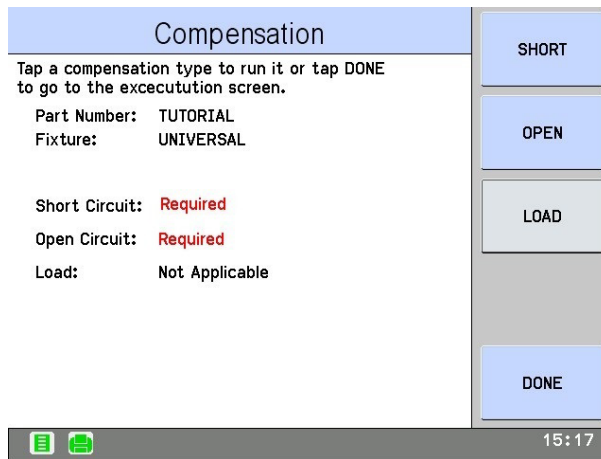

The screen shows which types of compensation apply to your test program (this depends upon the types of tests you have chosen in the test program). These will show as "Required" Or "Not applicable".

The screen also confirms if you have successfully compensated the program since the program was loaded. These show the date and time of compensation. See "AUTOMATIC COMPENSATION STORAGE" at the end of this section.

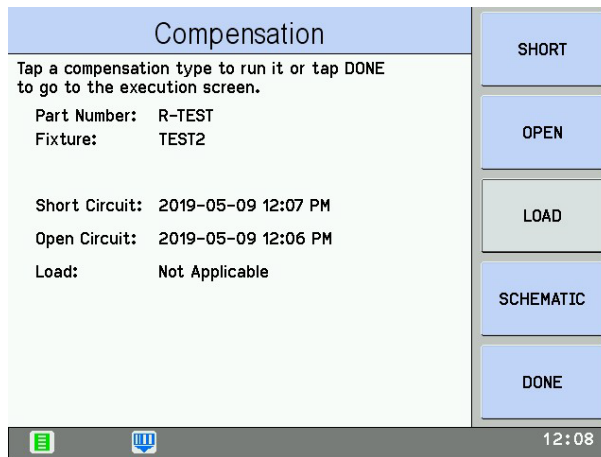

Use the active soft keys to enter the sub menu- for each compensation type.

SHORT CIRCUIT COMPENSATION

When the SHORT soft key is tapped, the following screen shall appear.

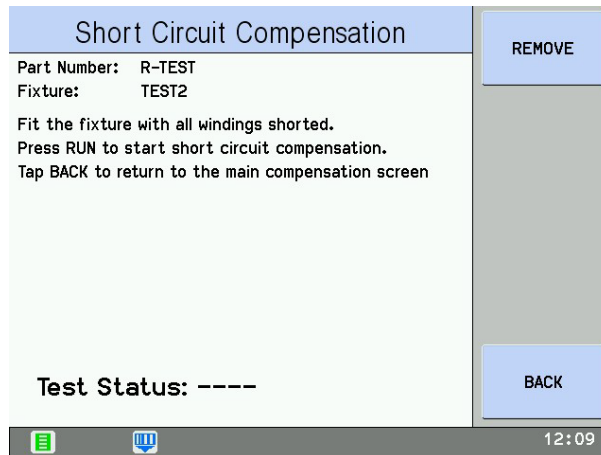

Follow the on-screen instruction then tap the RUN button, the short circuit compensation shall begin.

Tap the REMOVE button to clear any Compensation already applied.

Tap the BACK soft key to return to the previous menu.

When the AT5600 has completed the short circuit compensation process, the following screen will appear.

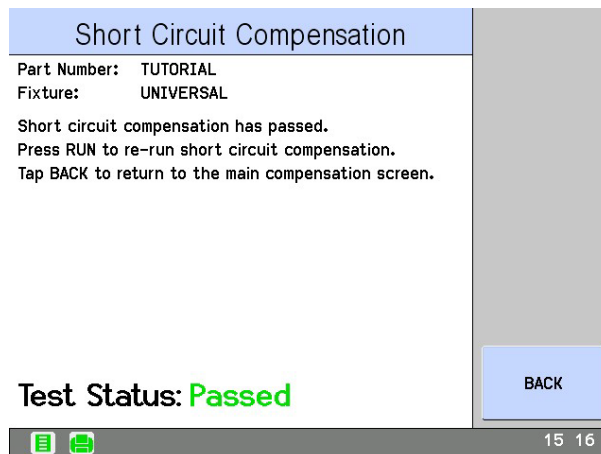

Tap the BACK soft key to return to the previous menu.

OPEN CIRCUIT COMPENSATION

When the OPEN soft key is tapped, the following screen shall appear:

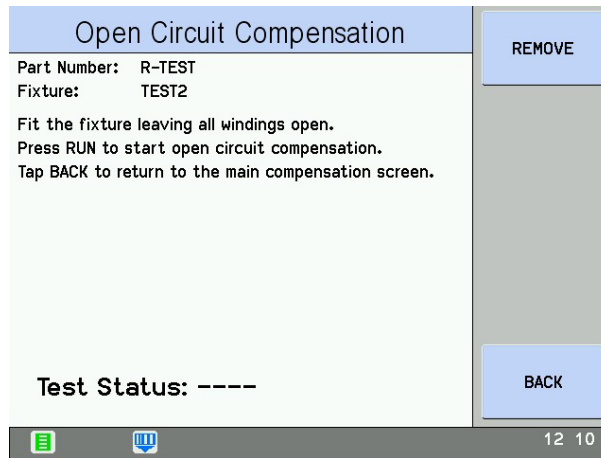

Follow the on-screen instruction then tap the RUN button to run the open circuit compensation.

Tap the BACK soft key to return to the previous menu.

Tap the REMOVE button to clear any Compensation already applied.

When the AT5600 has completed the open circuit compensation process, the following screen will appear.

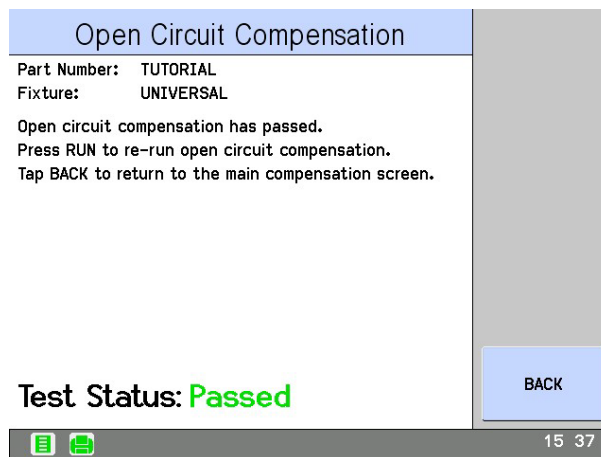

Tap the BACK soft key to return to the previous menu.

LOAD COMPENSATION (currently only for SURGE and LL tests)

When the LOAD soft key is tapped, the following screen shall appear:

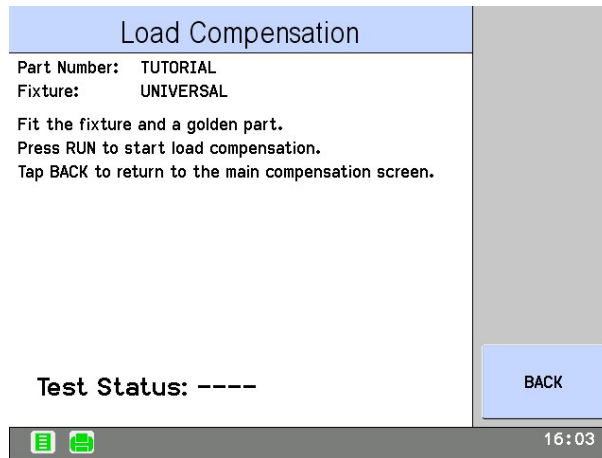

Follow the on-screen instruction then tap the RUN button to run Load compensation.

When the AT5600 has completed the load compensation process, the following screen will appear.

Tap the BACK soft key to return to the previous menu.

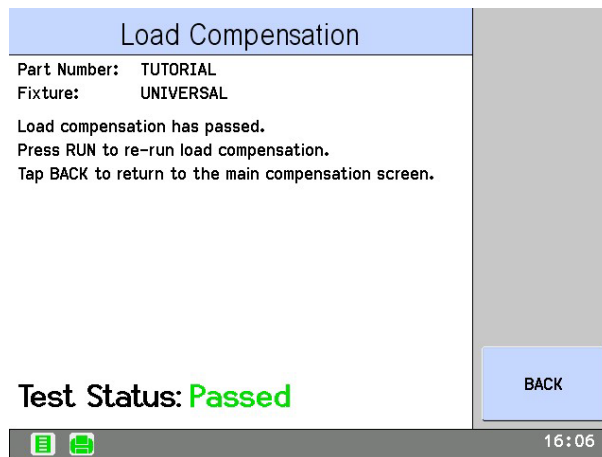

AUTOMATIC COMPENSATION STORAGE

New FREE feature for ALL USERS**Requires AT5600 Firmware V1.002.000 or later.****Free firmware upgrade file available from our download page.****How does Automatic Compensation Storage work?**

Every time a compensation is successfully applied it is also silently stored in the AT5600. If the same program is then re-loaded again, the last valid compensation is automatically loaded, and the date and time of the stored compensation is shown on the screen.

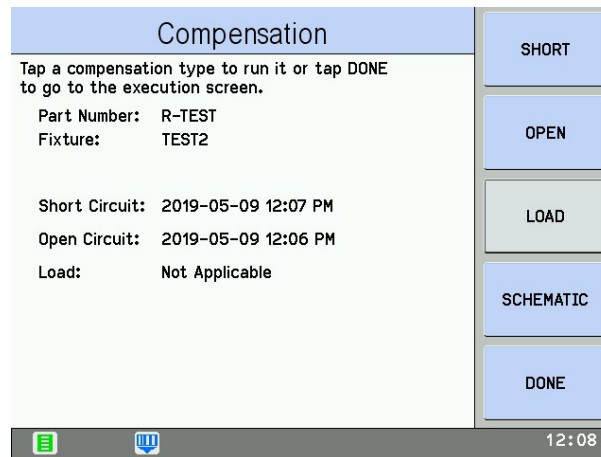

Each AT5600 will store the last valid compensation in its memory for the last 2000 programs. Only one stored compensation is allowed per test program.

If you wish, a new compensation can be performed at ANY time, if you prefer to remain compensating on every batch.

General Advice

1. Compensation, like any normal test run, should only be performed (and stored) when the unit has been warmed up for at least 30 minutes and self-test if confirmed to pass.
2. Compensation storage has no “memory” of the specific cables or fixture used to perform compensation. Hence if you have two similar fixtures moving between units there may be subtle differences between them. Cables, Clips, Kelvin blades and fixture contacts can also degrade or become dirty over time, so should be maintained, as it is the characteristics of these connections that compensation is designed to remove.
3. Stored compensation factors are a function of the specific unit and specific fixture/cabling. Hence there is deliberately no way to transfer a stored compensation from one AT to another.

Stored compensation will NOT be loaded if...

1. Any change is made to the test program between the last compensation and the next program load.

This is because any changes to test signals for frequency, or even adding extra tests, or re-ordering them, would render the stored compensation invalid.

The AT5600 silently checksums your test program to confirm the program has not changed and that any stored compensation is still valid.

2. You have deliberately discarded a saved compensation using the "REMOVE" buttons on the compensation screen.

3. You have not yet compensated the test program after the upgrade to firmware V1.002.000

8.1.6.6 Run Screen

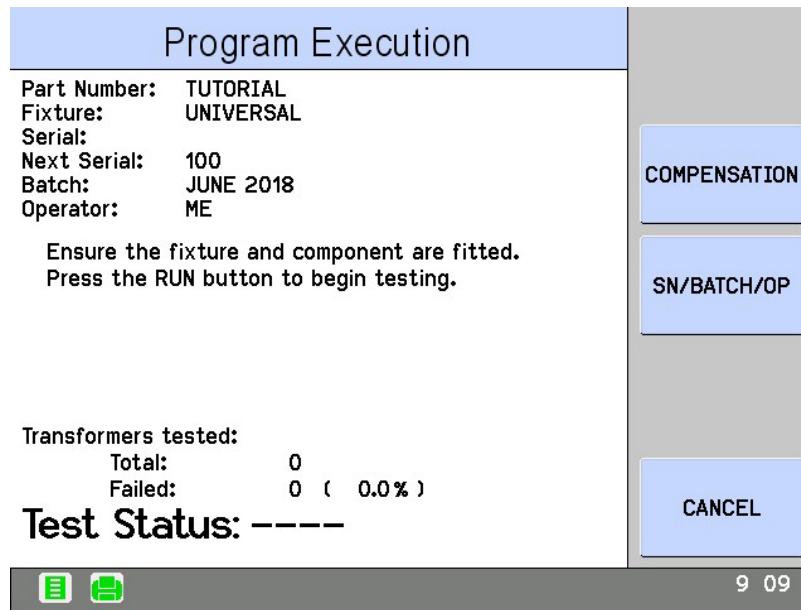

Once a program is loaded into the AT5600, connect the transformer to the fixture and press the Run button to begin testing the transformer.

When testing is complete, you will see the following display:

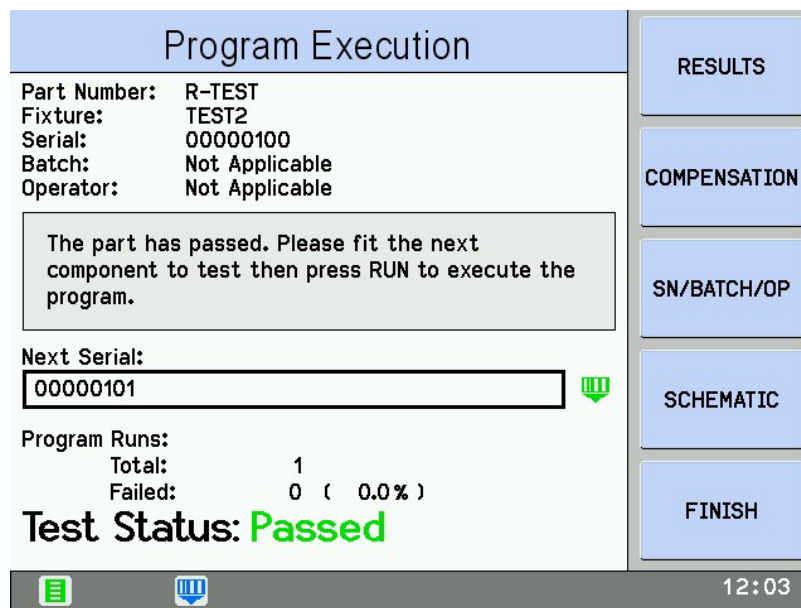

- RESULTS** show the results of the test.
- COMPENSATE** used to perform an Open, Short or Load Compensation.
- SN/BATCH/ OP** used to change the serial number of the part under test, or Batch Number, and Operator Number. The key is enabled only if the option(s) are selected in the test program.

For ease of use, The NEXT SERIAL number can also be set by either.

A, tapping into the Next Serial box and entering your next serial using the touch screen as normal.

B, using a barcode reader to scan the next serial number (the green icon indicates that barcode entry is allowed).

This barcode scan can be done directly on this screen WITHOUT the need to go into the sub menu.

SCHEMATIC	see section 8.1.6.8
FINISH	returns to the top-level screen

8.1.6.7 Results

To display the test results, tap the RESULTS soft key; you will see the following display:

Results						
Id	Type	Minimum	Maximum	Result	P/F	Error
1	R	30.60 Ω	37.40 Ω	37.30 Ω	P	0000
2	R	30.60 Ω	37.40 Ω	36.75 Ω	P	0000
3	R	-----	800.0mΩ	717.8mΩ	P	0000
4	R	-----	800.0mΩ	691.4mΩ	P	0000
5	VOC	13.30 V	14.70 V	14.04 V	P	0000
			POL+	POL+	P	
6	VOC	13.30 V	14.70 V	14.04 V	P	0000
			POL+	POL+	P	
7	VOC	109.3 V	120.7 V	114.9 V	P	0000
			POL+	POL+	P	
8	MAGI	-----	10.00mA	3.996mA	P	0000
9	IR	50.00MΩ	-----	2.411GΩ	P	0000
10	HPAC	-----	5.000mA	794.4uA	P	0000

PAGE UP

PAGE DOWN

PRINT

BACK

☰
📄
⌨
19:58

- PAGE UP used to scroll up the list.
- PAGE DOWN used to scroll down the list.
- PRINT used to print the results if USB printer attached.
- BACK Return to testing mode

8.1.6.8 Schematic

New Feature in Firmware V1.002.000

This screen provides a simplified view of your test program schematic.

It can be used in place of the AT Editor screen by the user to check the connections needed to test the items under test.

This sub screen is available any time for inspection from the COMPENSATION and RUN screens.

An example is shown below.

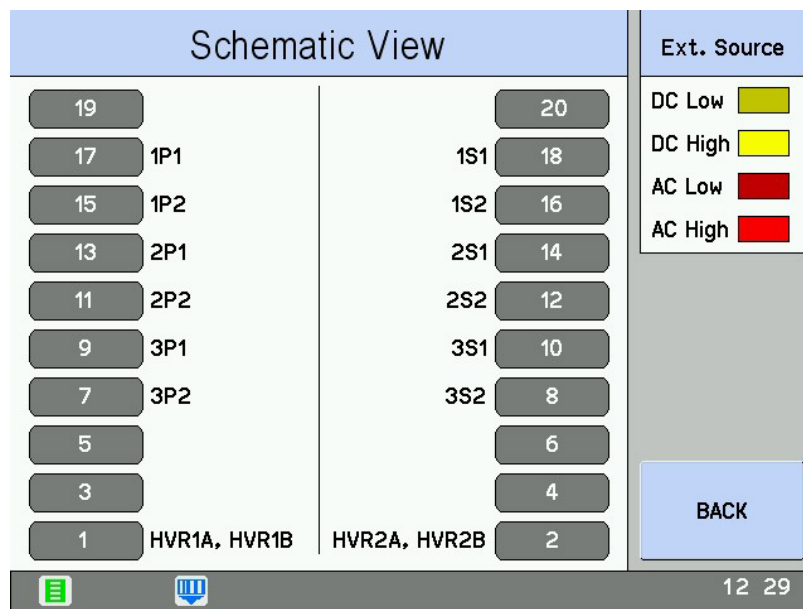

The grey boxes 1-20 represent the AT Test nodes.

The number inside these represent your programmed transformer terminals.

In the above example the transformer pin "1P1" should be connected to node 17, and so on.

Programs using the DC1000 25A DC bias source.

If you have programmed the LSBX LPBX or ZBX tests which also use the DC1000, then the nodes requiring the DC1000 output are also indicated by the light and dark yellow bars on the node numbers.

Remember that the connection polarity of these is important.

The DC1000 high output should be connected to the light-yellow node.
The DC1000 low output to the dark yellow node.

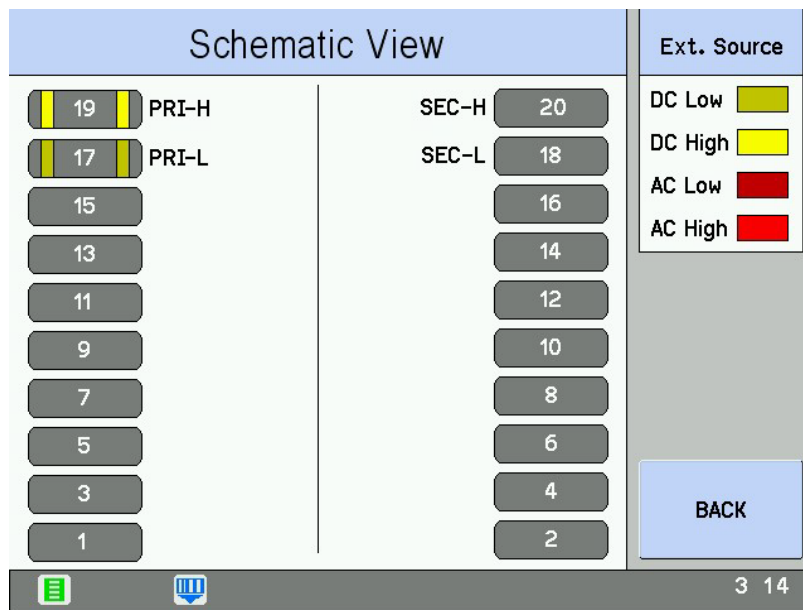

Programs using the AC INTERFACE FIXTURE

If you have programmed the VOCX MAGX WATX or STRX tests which also use the AC INTERFACE FIXTURE, then the nodes requiring the AC IF output are also indicated by the light and dark red bars on the node numbers.

Remember that the connection polarity of these is important.

The ACIF high output should be connected to the light red node.
The ACIF low output to the dark red node.

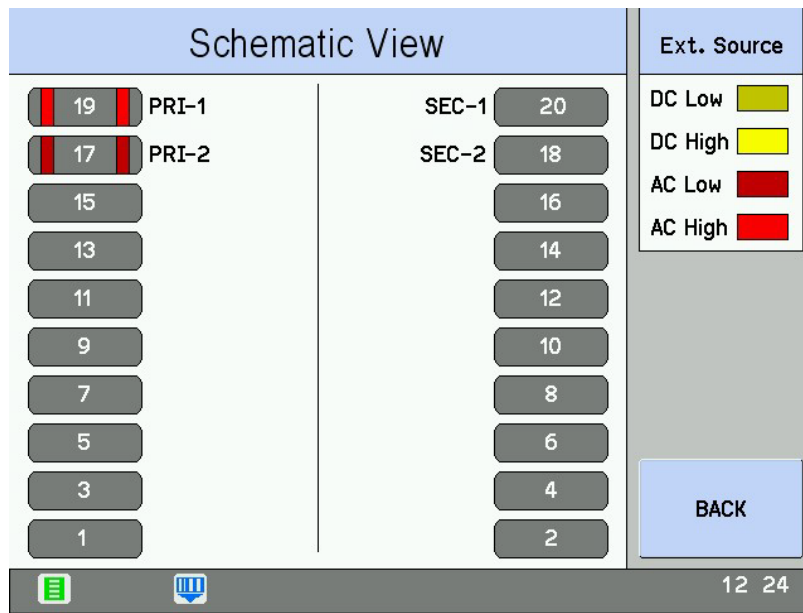

8.1.7. Self-Test

The self-test is a sequence of checks made by the tester to ensure the unit is functioning correctly.

It cannot check that measurements will be made to specification, but it can check that most functionality is working correctly.

Although the AT5600 will automatically detect and report most faults that may cause incorrect measurements, it is recommended to run a self-test at the start of each day for added confidence that the AT5600 is operating correctly.

Before commencing system test, please ensure that there is no fixture fitted and nothing is touching any of the test nodes on the top surface of the AT5600. The self-test shall only run if the Safety Interlock is in the safe condition.

CAUTION: If the connections have been correctly made to the Safety Interlock, safe condition, then high voltage, generating up to 7000V, shall be present on all the test nodes on the top surface of the AT5600.

You may run Self-test at any time by tapping the SELF-TEST soft key in the top-level screen. Once the SELF-TEST soft key is tapped, you will see a display like the following:

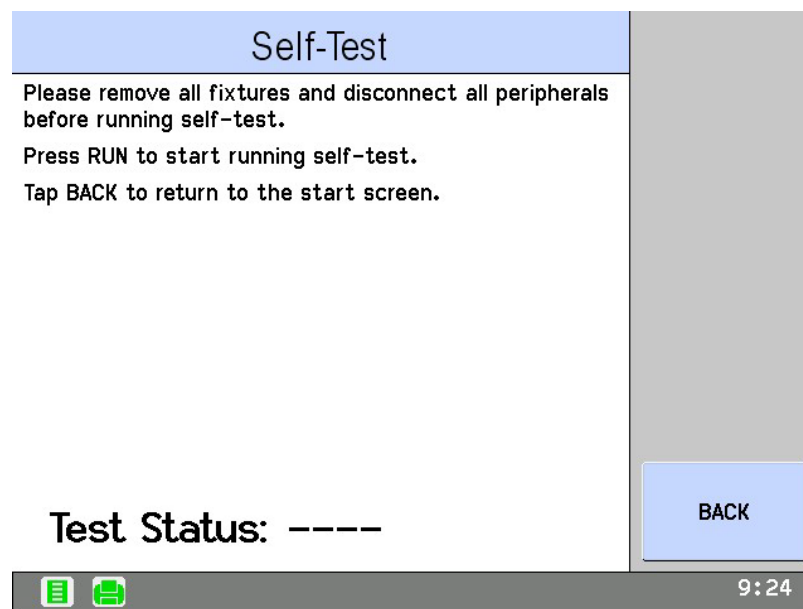

- BACK – Return to the main menu.

Press the RUN button on the front panel to begin the Self-Test.

As the self-test is running, the front panel display will indicate the Test Status: Running as shown below.

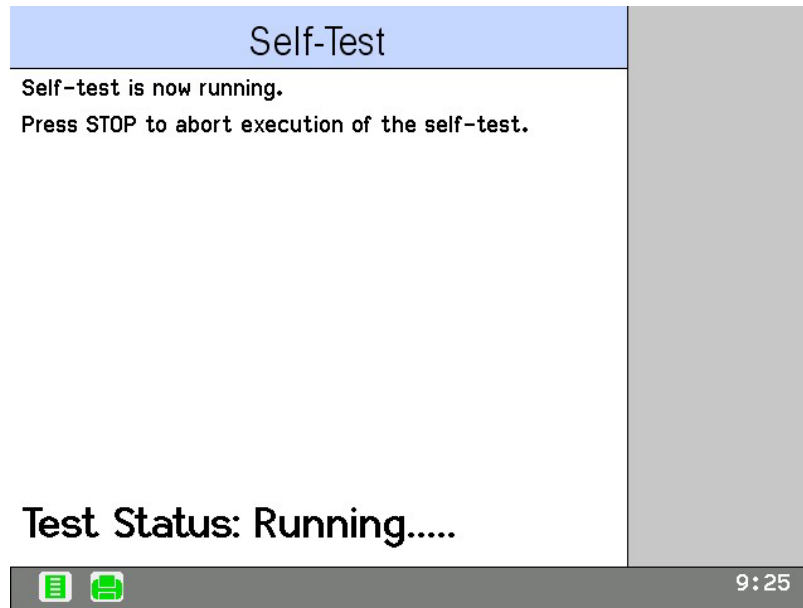

Press the STOP button to abort the self-test.

At the end of the self-test, you shall see the following screen:

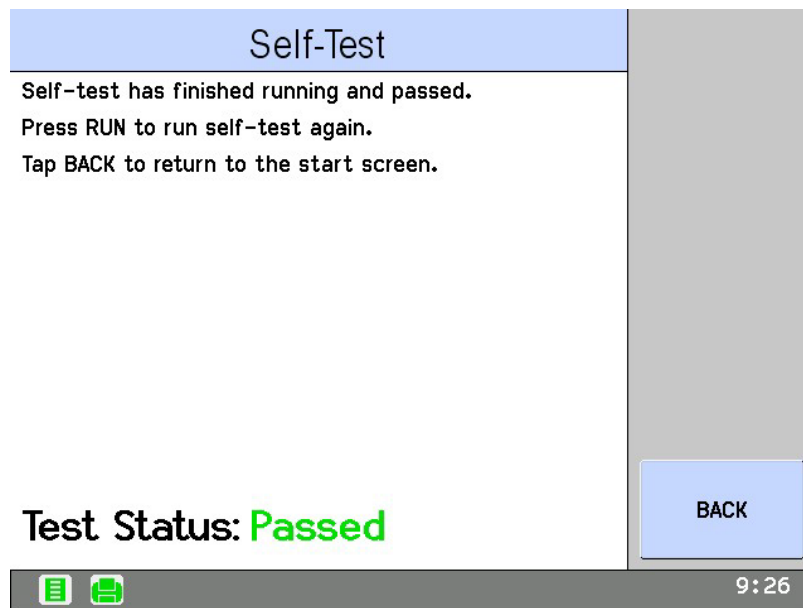

BACK – return to main menu.

If there is a failure found in the self-test, follow the instruction outlined in section 14.8 for a listing of the results and contact your Voltech supplier for service.

8.1.8. Set-Up

Set up allows the adjustment of the AT5600 options that effect the way the unit runs tests and stores results.

You may change the System parameter at any time. Tap the SET UP soft key in the top-level screen. Once the SET UP soft key is tapped you will see a display like the following:

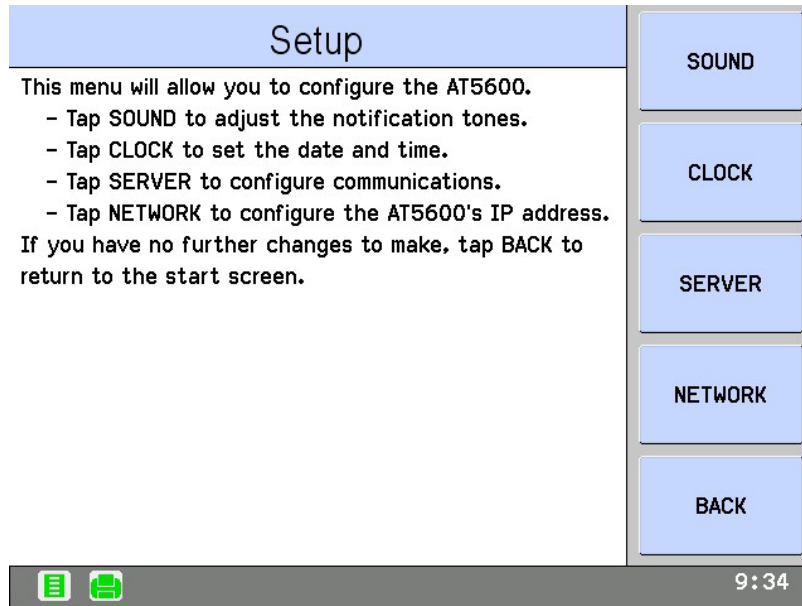

- | | |
|---------|--|
| SOUND | changes the internal Beeper options. |
| CLOCK | changes the time and date of the internal Time Clock |
| SERVER | setup the Server mode method and Ethernet IP. |
| NETWORK | DHCP or Static IP, if using Ethernet |
| BACK | return to the top-level screen |

8.1.9. Sound

The SOUND soft-key changes the way the internal Beeper sounds or to turn off the sound for functions such as Failure indicator, Pass indicator, Soft-keyboard sound.

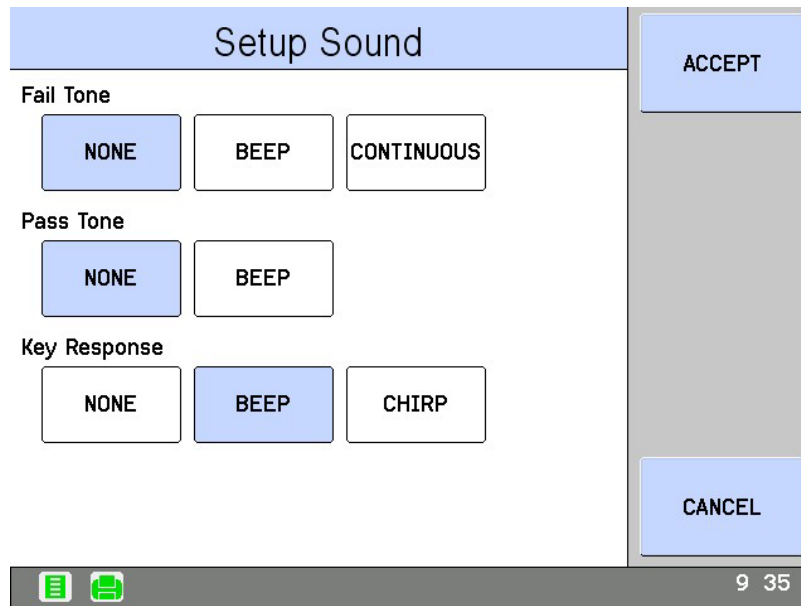

ACCEPT change the internal beeper settings.

CANCEL return to the previous screen, without accepting the changes.

8.1.10. Clock

The CLOCK soft key allows the user to change the time and date of the internal Real Time Clock.

You also have the option to change the time format to 12-hour or 24-hour.

Once the CLOCK soft key is tapped, you will see a display like the following:

Set the time and date accordingly then tab the ACCEPT to save changes and returns to the previous screen.

- ACCEPT save the changes and returns to the previous screen.
- BACKSPACE clear the last character entered.
- CANCEL return to the previous screen without accepting changes.

8.1.11. Server

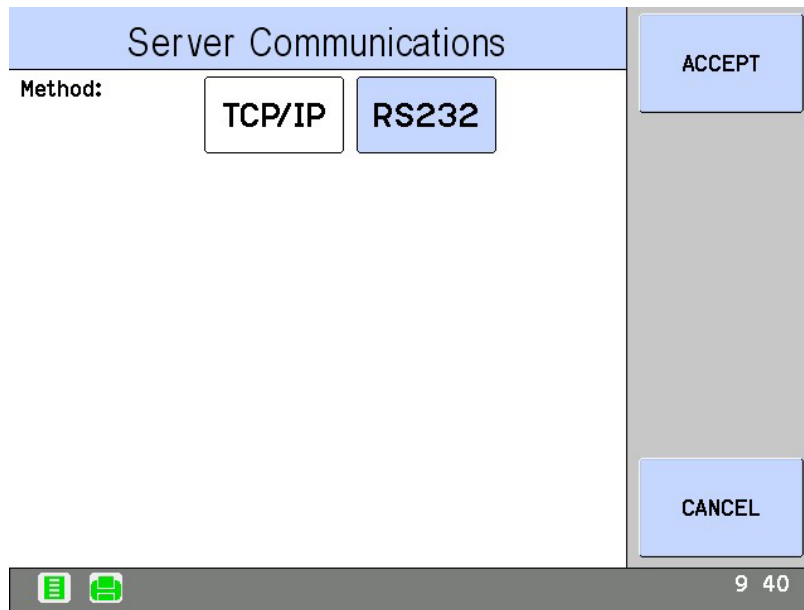

Select the method to communication with the Server. Choices are RS232 or TCP/IP(Ethernet.)

If you choose TCP/IP for Ethernet, then enter the IP of the PC running the AT SERVER software.

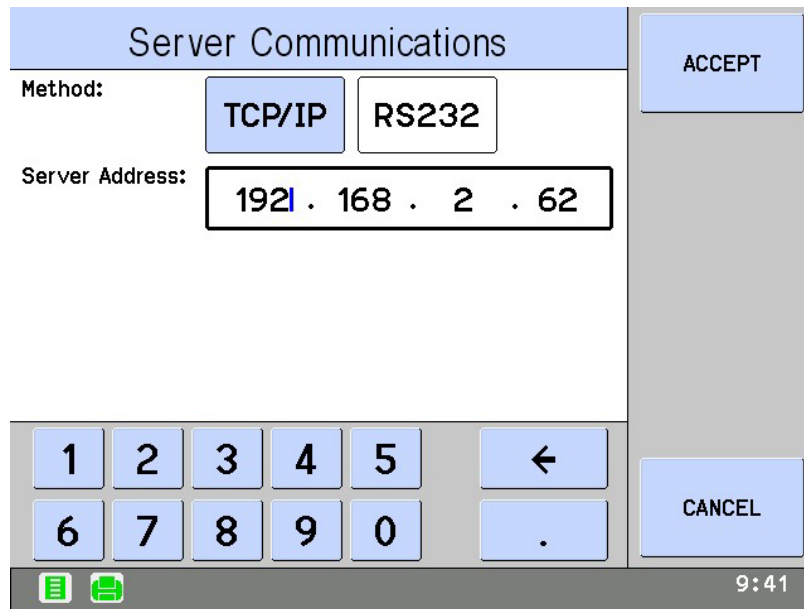

ACCEPT save changes and return.

CANCEL return to the previous screen without changes.

8.1.12. Network

This soft key allows the user to configure the way the AT5600 connects to your internal network, if using Ethernet.

When the DHCP is selected the AT5600 shall acquire an available IP address from your network automatically.

When Static is selected, the parameter must be set-up manually. i.e., Static IP, Default Gateway. And Subnet Mask.

Please consult your IT department if unsure as to the specific mode and setup information applicable to your installation.

The screenshot shows the 'AT5600 Network Address' menu. At the top, there is a title bar. Below it, the text 'Address DHCP:' is followed by two buttons: 'DHCP' (which is highlighted in blue) and 'Static'. To the right of these buttons are two larger buttons: 'ACCEPT' at the top and 'CANCEL' at the bottom. At the bottom of the screen, there is a status bar with two green icons on the left and the time '9:42' on the right.

The screenshot shows the 'AT5600 Network Address' menu with 'Static' selected. The 'DHCP' button is now grey and 'Static' is highlighted in blue. Below the mode selection, there are three input fields: 'IP Address:' containing '192 . 168 . 2 . 20', 'Default Gateway:' containing '0 . 0 . 0 . 0', and 'Subnet Mask:' containing '255 . 255 . 255 . 0'. Below these fields is a numeric keypad with buttons for digits 1-5, 6-0, and a left arrow key. To the right of the keypad are 'ACCEPT' and 'CANCEL' buttons. The status bar at the bottom shows the time '9 43'.

8.1.13. Compatibility

8.1.13.1 AT3600 Compatibility Mode

This feature allows you to quickly load compensate an entire test program against a set of AT3600 results using a golden part as a transfer standard.

This feature is only available with the latest AT5600 firmware AND when used with the new dotNET AT SERVER

This is useful in cases where you are using test limits tighter than the AT3600 or AT5600 spec and wish to maintain one program of use on both units.

For example, it will help with use of the SURGE test. The SURGE results are a characteristic Volt-second product of both the UUT and the internal hardware of the AT36/AT56 unit being used. Due to differences in design the AT5600 and AT3600 may give different (but both valid and repeatable) readings for the same part.

The compatibility mode allows you to scale the AT5600 results to match the AT3600 results, whilst still applying your usual Pass/FAIL limits as needed.

How does it work?

If compatibility mode is enabled on an AT5600, then on a program download, the AT5600 will request the average results of any previous PASS AT3600 test data that is already stored in the dotNET AT Server.

The program is then load compensated against a physical golden test part, and the scaling factors saved as the load compensation in the AT5600.

The test program is not altered in anyway, so is still valid for AT3600/ATi use.

The load compensation is only stored in the specific AT5600 and can be removed or reapplied using the compensation screen.

The feature can be turned OFF at any time to revert to normal AT5600 measurements.

How to use AT3600 Compatibility mode

- 1, Connect an AT3600 to the dotNET Server
2. Run some AT3600 results for your chosen test program into the dotNET Server. This can be using a batch of parts, or the same part tested repeatedly. To get the best results we recommend at least 10 PASS results should be saved to the AT SERVER.
- 3, On the AT5600 under SETUP > COMPATIBILIT, set AT3600 Compatibility mode to ON and ACCEPT
- 4, Connect the AT5600 to the same dotNET SERVER, and load the same test program into the AT5600
- 5, The compensation screen with give you the usual SHORT and OPEN compensation options, run these as normal if needed.
- 6, LOAD compensation will also be shown as required
- 7, Fit the golden transfer standard part (that you ran on the AT3600) to the AT5600 and run load compensation
- 8, As with Short and Open compensation, the load compensation will also be stored in the AT5600 and can be removed or re-applied at any time.
- 9, Run your normal batch of parts through the AT5600 in the usual manner.
- 10 The results will be automatically scaled.

Notes

The Load compensation nominal values that will be used will only be taken from previous AT3600 Passed results.

Any AT3600 results that predate the last test program edit will be ignored – for example you could have edited the program to add extra tests or change V or F – These are not considered as the test program has changed.

8.1.13.2 Language

This allows you to change to change the AT5600 languages into other languages.

At the time of writing this is only a choice of English or Chinese

More languages will be added in future.

8.1.14. Unit Information

This page displays basic unit information.

BACK to return to previous screen

TEST LIST to display the test options that are enabled.

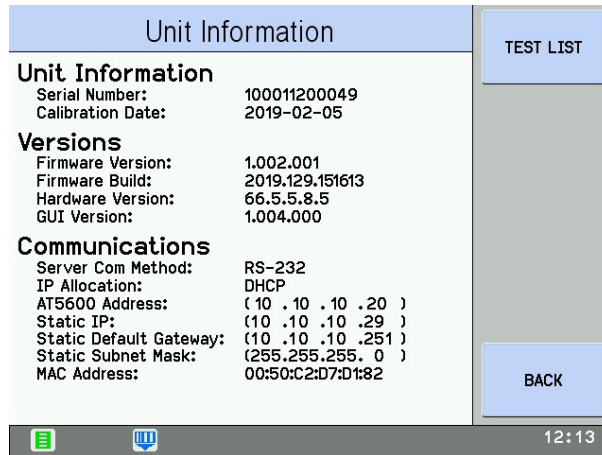

TEST LIST

This displays the available tests on this unit and can be either.

Unlocked Permanently available to use.

Trial Available in demo mode until the 30-day demo expires
See front screen for Trial Days Remaining

Locked Not available.

If you would like to try any of the tests you currently do not own, please contact us and we can issue a 30-day demo code to enable them for you to try.

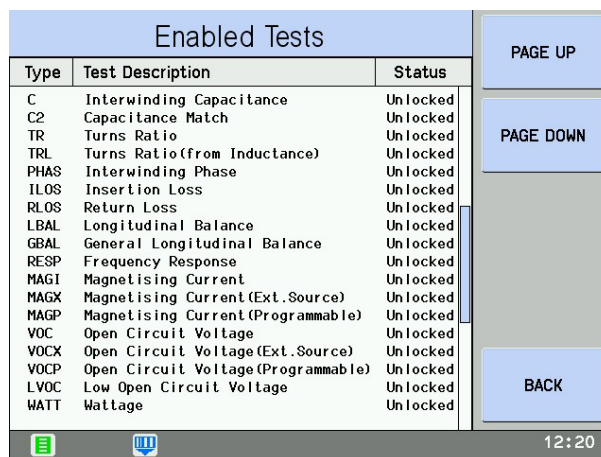

8.1.15. Status Bar Icons

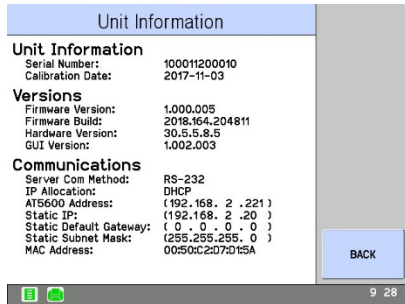

INTERLOCK CLOSED

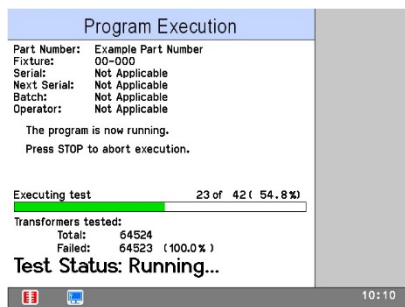

INTERLOCK OPEN and COMMS icon

First (left) icon indicates SAFETY INTERLOCK status

This is GREEN when the interlock is closed and will allow testing to proceed.

This is RED when the interlock is open, which will prevent any testing being run.

Second is the COMMUNICATIONS icon.

This is shown when the unit is communicating with the AT SERVER to send test results, or when the AT is being controlled by the AT EDITOR.

USB-A 1 + 2 Port Icons

To the left of the clock are two icons showing the status of the two USB A ports
(“1” on the front left of the unit, “2” on the rear of the unit)

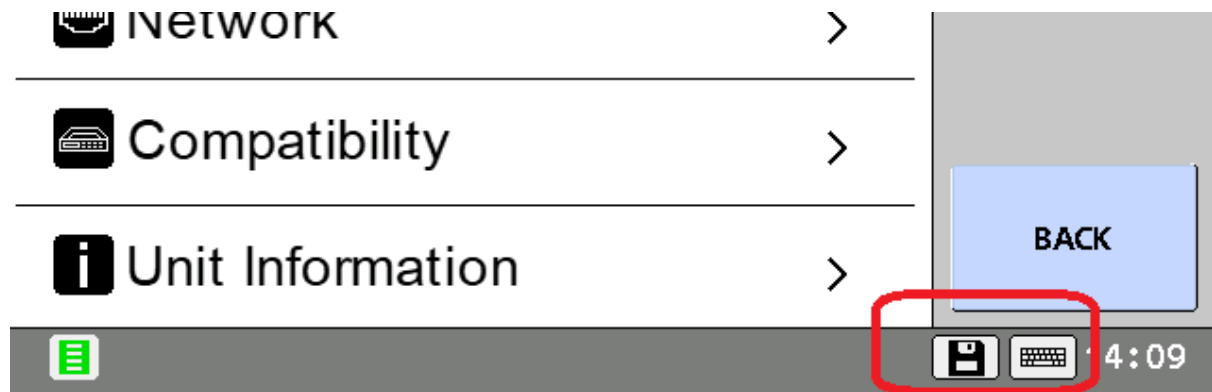

PRINTER icon

This is only shown when a valid USB printer is connected and available for use on the AT5600 USB-A port.

KEYBOARD Icon

This is shown when a valid USB keyboard is available on the USB-A port.

BARCODE READER Icon

This is shown when a valid barcode reader is available on the USB-A port.

8.2. Testing Wound Components

8.2.1. A Typical Workflow

The below shows the basic test execution flow, and the possible sequence of user inputs (set in the AT EDITOR program options) during testing.

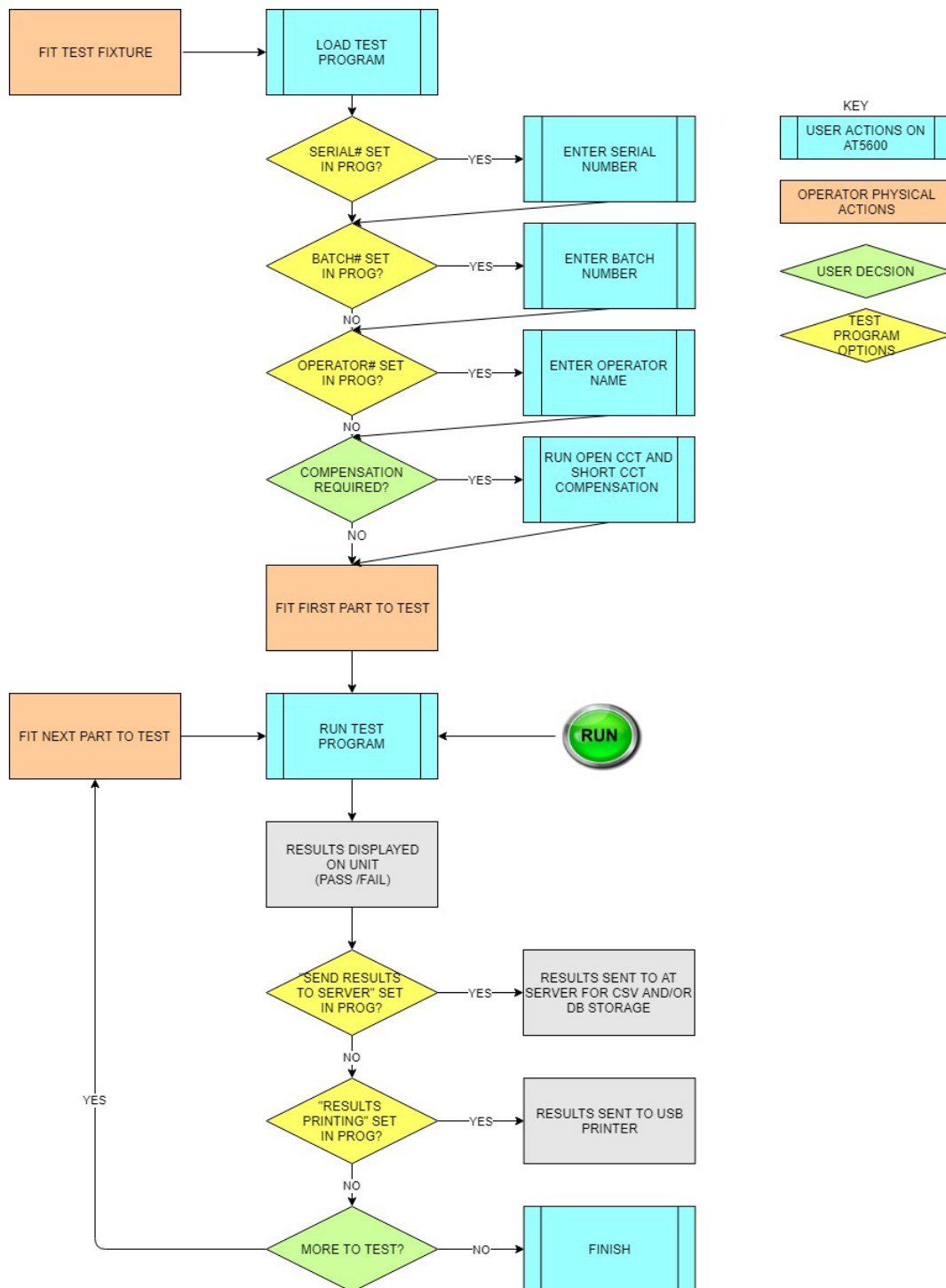

8.2.2. Traceability

To provide traceability of results, the system allows optional tagging with serial number, batch number, and operator name.

This information, the measurements and the pass-fail verdict can be.

A) printed to USB printer.

And/or

B) Saved with any results to CSV, MS SQL, or MS ACCESS, if the Save Results to the Server option is enabled in the ATP program.

8.2.3. STOP ON FAIL function.

The test program is executed by pressing the RUN button or providing a RUN input to the remote port using a foot switch or another device.

Using the STOP ON FAIL option (set in the program in the AT EDITOR test options) also provides you with extra control in the event of a test failure. This allows you to stop “false” FAIL results caused by misconnection from being recorded to the Server. It can also save time on longer test programs with genuine fails. See below for description of this functionality.

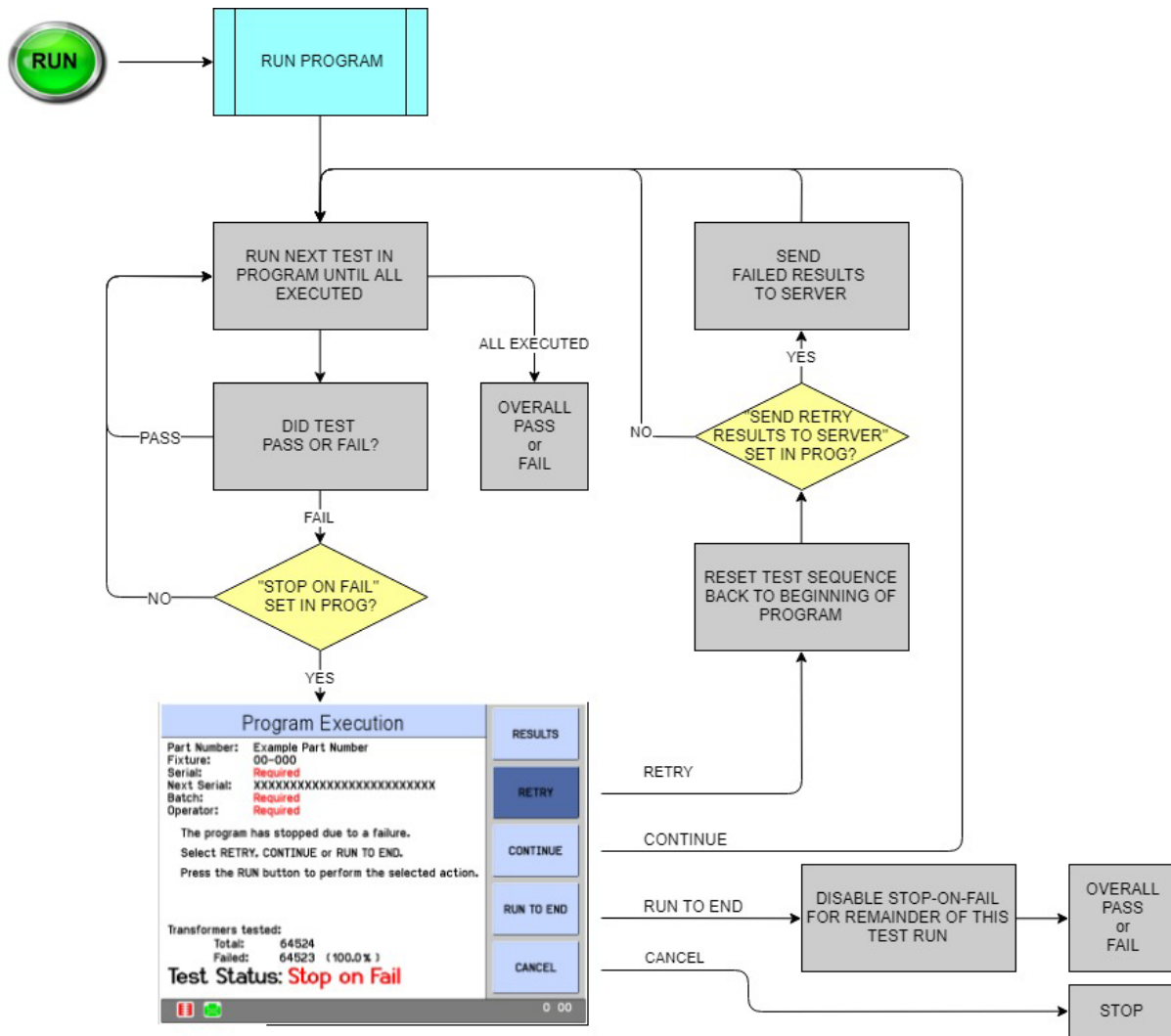

KEY

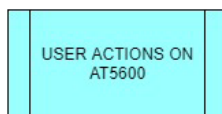

8.2.4. Getting the Results

Program Execution

Part Number: TUTORIAL
 Fixture: UNIVERSAL
 Serial: 100
 Next Serial: 101
 Batch: JUNE 2018
 Operator: ME

The part has passed. Please fit the next component to test then press RUN to execute the program.

Transformers tested:
 Total: 1
 Failed: 0 (0.0%)

Test Status: Passed

RESULTS

COMPENSATION

SN/BATCH/OP

FINISH

☰

📄

9 13

The Test Status of the last part (Pass or Fail) is clearly shown in the main window and tapping the results soft key will display a results grid, showing the results of all tests executed in the test program.

Results

Id	Type	Minimum	Maximum	Result	P/F	Error
1	R	30.60 Ω	37.40 Ω	37.30 Ω	P	0000
2	R	30.60 Ω	37.40 Ω	36.75 Ω	P	0000
3	R	-----	800.0mΩ	717.8mΩ	P	0000
4	R	-----	800.0mΩ	691.4mΩ	P	0000
5	VOC	13.30 V	14.70 V	14.04 V	P	0000
			POL+	POL+	P	
6	VOC	13.30 V	14.70 V	14.04 V	P	0000
			POL+	POL+	P	
7	VOC	109.3 V	120.7 V	114.9 V	P	0000
			POL+	POL+	P	
8	MAGI	-----	10.00mA	3.996mA	P	0000
9	IR	50.00MΩ	-----	2.411GΩ	P	0000
10	HPAC	-----	5.000mA	794.4uA	P	0000

☰

📄

🖨️

19:58

If the “Send results to Server” program option has been set, then the results will be sent back and recorded in the server software.

Results Printing

If the test program options have been configured to allow printing (see section 14.5.1) then a printout will automatically be sent to the USB printer.

The PRINT soft key can also be used to manually trigger a print of the results, even if printing is not enabled in the test program.

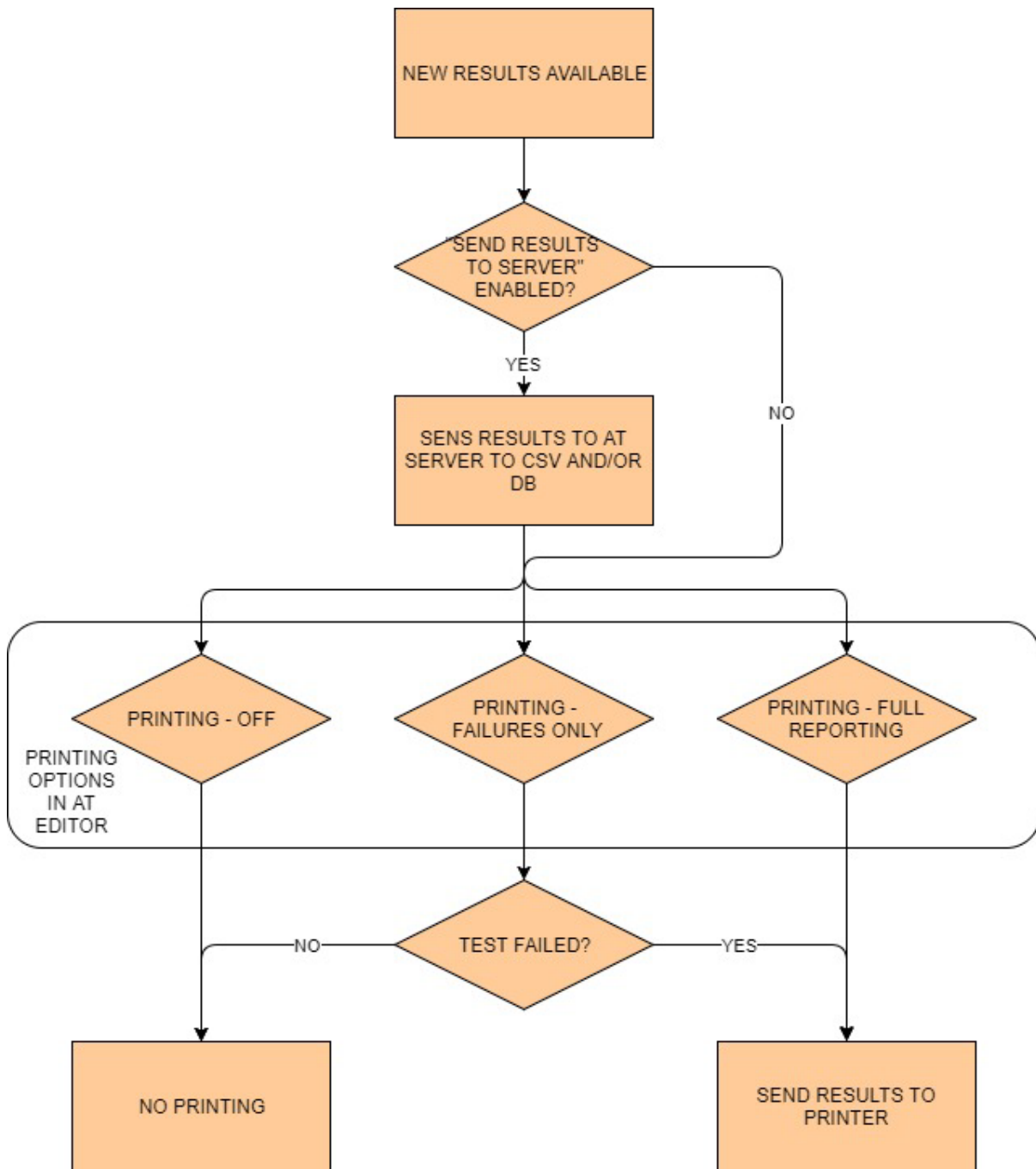

9. Troubleshooting

Understanding status codes and diagnosing problems

9.1. Measurement Error Codes

The AT5600 provides measurement error codes along with all measurement results to provide extra information about the result and any warnings that may affect the integrity of the result.

During any test measurements, voltage and current signals are constantly being generated, stabilized, measured, and trimmed. Should a problem occur during one of these four stages then a unique error code is produced and displayed along with any results. The status code is called the Measurement Status Code and is a 4-digit hexadecimal number. The codes are described in Section 9.1.3

The Measurement Status Code (MSC) represents a series of binary bits (0's and 1's) that each flag a measurement property as true or false, such as a current or voltage over range, that can help the operator diagnose the cause of the problem. The MSC is seen on self-test results, program run results, and Editor Result's screens.

For the operator, this status code can assist in determining if a fault is due to a poor fixture or an incorrectly seated part, or it could prompt an investigation into the appropriate test parameters being used. For more serious faults, it can help provide details to pass to Voltech technical support.

9.1.1. Test error codes

If the test fails, then a list of all the failure that the self-test found shall be listed in the Results. If the AT5600 fails, the Self-Test then please contact your nearest Voltech service centre or Voltech technical support providing the details of the self-test failures.

9.1.2. Editor Error Codes

Measurement Status Codes are also shown when using the Editor software after running a program. They are shown to the right of each test result.

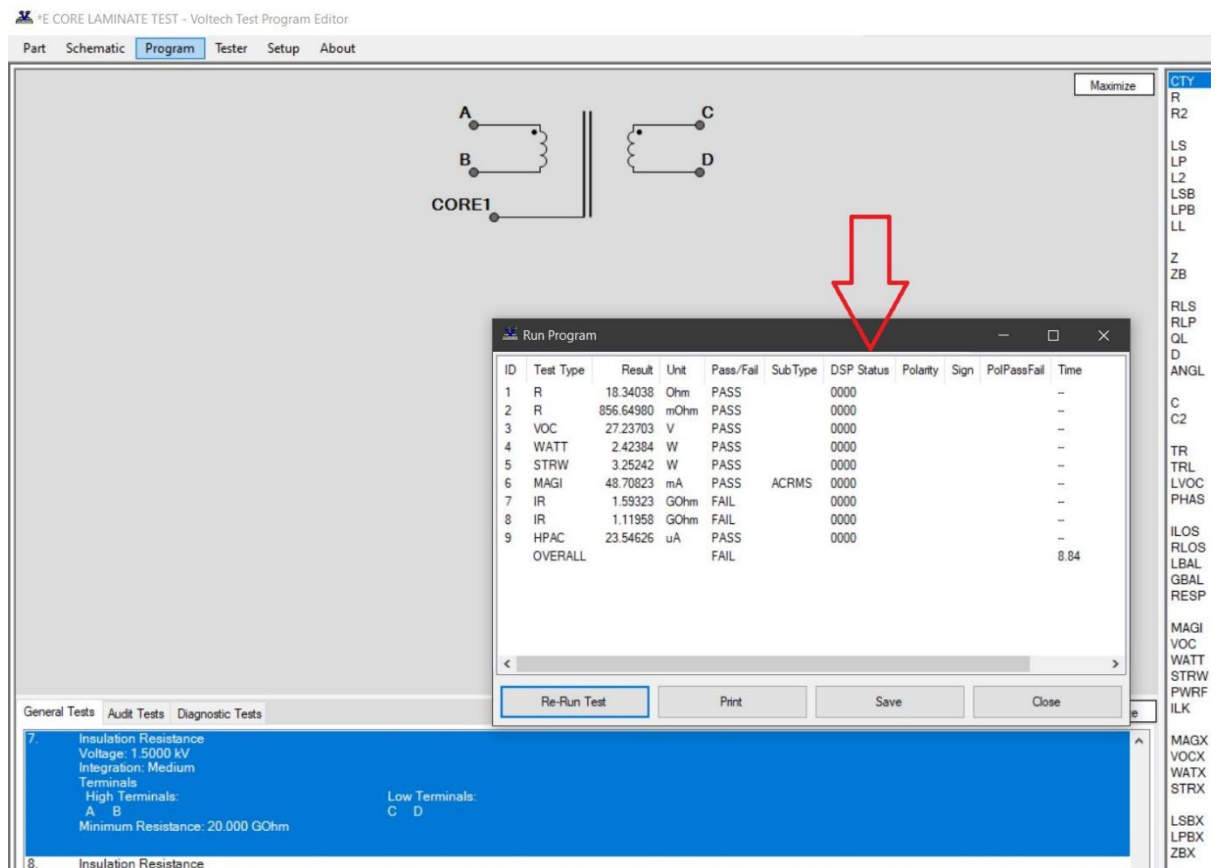

9.1.3. Status Code Example

If you look at the test results screen shown above, you will see that test 4 (LBAL) shows a status code of 0010. This code indicates that “The measurement had not settled in time.” Although this test passed, it indicates that a problem existed during the test sequence, and the result may not be accurate to the published specification.

The status code is a 16-bit binary code, which is shown in hexadecimal notation.

The following shows the meaning of each bit which represents one measurement property so that more than one status can be shown at the same time. For example, if a voltage over-range (xxx1) and a current over-range (xxx2) have occurred at the same time during the measurement, then the status code is 0003 (i.e., both bits 0 and 1 are set, so the binary value is 0000000000000011). If a test has been interrupted, then an additional code is set in bits 12-15 of the status code.

Status Error Codes

Hex Code	Meaning
0000	Test passed with no errors.
xxx1	Voltage over-range occurred.
xxx2	Current over-range occurred.
xxx4	Ramp-up process has been aborted; too much load.
xxx8	Error reported by the DC bias unit or that the DC bias unit did not respond to a command.
xx2x	The test signal could not be trimmed to required value; incorrect test parameters for the load.
xx4x	An error occurred after ramp-down; current did not decay away in time.
x1xx	Current limit fail (Hi-pot tests only); test current exceeded pre-programmed limit.
x2xx	The measured voltage did not go away in time; something on the fixture is staying charged.
#4xx	The test has been interrupted (see table below).
Where # = reason for the interrupt.	
1	The safety interlock was broken during the test
2	Power more than limit requested. Power is above 25W. If this power level is exceeded, we abort the test
3	A Hi-pot current trip has terminated the test, i.e., a flashover (spark) has occurred, or the current has exceeded the AT's current capabilities (can occur on HPAC, HPDC, and IR).
4	A STOP input has terminated the test from the STOP input of the remote port or the STOP button on the front panel
5	An 8KV overvoltage has been detected and terminated the test.
6	Class D overload. A hardware trip to protect the unit if >4A has been detected for greater than a few microseconds.
7	An over-temperature interrupt has terminated the test; unit has become too hot.
8	An auxiliary fault interrupt has terminated the test; this can be created by an accessory attached to the peripheral port.
9	Unit rebooted during the test sequence.

9.1.4. Common error codes.

In most cases, you should expect to have an error code of “0000” indicating that the test was executed under the required (and stable) conditions.

Some examples of ones you may sometimes see, follow.

3400 Hi Pot Flashover

This indicates a Hipot flashover.

In the case of testing a genuinely bad part that fails a HPAC or HPDC tests, you would expect to see this code and regardless of the measured result the test will be a FAIL.

This indicates a failure due to a sudden flashover. Remember that HPAC or HPDC tests can also fail just on the current flow measurement to the mA or uA max limit that you have programmed.

0020 Signal Trim error

This can be caused on the “LCR” style tests where the requested V / F cannot be met due to the matching of your UUT to the 50-ohm output impedance of the LPG (Low Power Generators.)

See section 4.1.5 for a technical description of this effect, which is common to any LCR meter too.

See also our webpage on this.

<https://www.voltech.com/applications/at5600-0020-status-error-codes/>

9.2. Correcting Errors

9.2.1. Safety Interlock error

The safety interlock system must employ all three control lines and if they are not all being switched correctly then the safety interlock icon will turn RED,

See section 10.3.5 for details of the safety interlock interface.

The screenshot shows a software interface titled "Program Execution". On the left, it displays the following information:

- Part Number: TUTORIAL
- Fixture: UNIVERSAL
- Serial: 101
- Next Serial: 102
- Batch: JUNE 2018
- Operator: ME

Below this information, a message states: "The program has been stopped by a break in the safety system. Please clear the safety interlock and press RUN to try again."

Further down, it shows "Transformers tested:" with a table:

Total:	1
Failed:	0 (0.0%)

At the bottom of this section, the "Test Status" is displayed as "Safety Interlock" in red text.

On the right side of the interface, there are four buttons: "RESULTS", "COMPENSATION", "SN/BATCH/OP", and "FINISH".

At the very bottom of the screen, there is a status bar with two icons (a red one and a green one) and the text "9 53".

9.2.2. Temperature error

If the AT5600 gets too hot, then an error message indicating an Over Temperature shall be displayed in the error message window.

Overheating can be caused by many factors.

1. Clogged air filters
2. Blocked air vents
3. Ambient temperature too high
4. An internal fault

If a temperature error is shown on screen or in any Measurement Status Codes, then make sure adequate space is allowed around the air vents (see 2.6) and clean the air filters as shown in section 11.1.



9.2.3. Voltage Present Error

This message is a serious error indicating that voltage may still be present on the AT5600 fixture.

After any HPDC, HPAC or IR test, the nodes used in that test are connected internally to a discharge resistor (330 KOhm for DC, 50 KOhm for AC) to ensure any voltages are removed before opening the relays and progressing to the next test.

This prevents any hot switching of the relays and ensures longevity of the unit.

If after a maximum 3 seconds, the Voltage present has not decayed to below 100V or 5mA, then a VPRES error is posted.

This is typically seen as a 0240 or 0040 error code (see 9.1.2 for error codes)

With AC INTERFACE

If seen, the power to any external AC sources must be switched off first, followed by the power to the AT5600. When it is certain that any hazards have been removed, any fixture should be removed to the AT5600 before being switched back on, and then a self-test system test initiated to check the AT5600 for any faults.

If the AT5600 is found not to be faulty (i.e., passed self-test) then the cause of this error must either.

1. An external source connected incorrectly.
2. A faulty Voltech AC interface fixture
3. A capacitance is becoming charged within the part under test.

Without AC INTERFACE

If an external source is not being used, then the problem is most likely to a capacitance charging during a Hi-pot test (normally HPDC).

You must make sure that any capacitance is limited to 30nF. Although the AT5600 is capable of discharging capacitance values higher than this, in the case of a single fault occurring within the AT5600, a part may not be discharged correctly (even when the safety interlock is broken) and any more than 30nF may be dangerous to the operator.



10. Specifications

10.1. Specification Summary

10.1.1. Low Voltage Tests

Test	Name	Measurement Range			Test Signal			Test Frequency			A _R ⁽¹⁾
CTY	Continuity	10 kOhm	to	50 kOhm							n/a
R	DC Resistance	500 uOhm	to	50 kOhm							0.10%
LS	Inductance (series)	1 nH	to	1 MH	1 mV	to	5 V	20 Hz	to	3 MHz	0.05%
LP	Inductance (parallel)	1 nH	to	1 MH	1 mV	to	5 V	20 Hz	to	3 MHz	0.05%
QL	Quality Factor	0.001	to	1000	1 mV	to	5 V	20 Hz	to	3 MHz	0.50%
RLS	Equivalent Series Resistance	10 mOhm	to	10 Mohm	1 mV	to	5 V	20 Hz	to	3 MHz	0.05%
RLP	Equivalent Parallel Resistance	10 mOhm	to	10 Mohm	1 mV	to	5 V	20 Hz	to	3 MHz	0.05%
D	Dissipation Factor	0.001	to	1000	1 mV	to	5 V	20 Hz	to	3 MHz	0.50%
LL	Leakage Inductance	1 nH	to	1 kH	20 mA 1 mV	to	100 mA 5 V	20 Hz	to	3 MHz	0.10%
C	Interwinding Capacitance	100 fF	to	1 mF	1 mV	to	5 V	20 Hz	to	3 MHz	0.10%
TR	Turns Ratio +Phase	1:100 k	to	100 k:1	1 mV	to	5 V	20 Hz	to	3 MHz	0.10%
TRL	Turns Ratio by Inductance	30 - 1	to	1 - 30	1 mV	to	5 V	20 Hz	to	3 MHz	0.10%
LVOC	Low Voltage Open Circuit	1 mV	to	650V (3)	1mV	to	5 V	20 Hz	to	3 MHz	0.10%
LSB	Inductance with DC Bias (Series)	1 nH	to	1 MH	1 mV 1 mA	to	5 V 1 A	20 Hz	to	3 MHz	0.05%
LPB	Inductance with DC Bias (Parallel)	1 nH	to	1 MH	1 mV 1 mA	to	5 V 1 A	20 Hz	to	3 MHz	0.05%
R2	DC Resistance Match	1-1000	to	1000-1							0.20%
L2	Inductance Match	1-10000	to	10000-1	1 mV	to	5 V	20 Hz	to	3MHz	0.10%
C2	Inter-winding Capacitance Match	1-1000	to	1000-1	1 mV	to	5 V	20 Hz	to	3 MHz	0.20%
GBAL	General Balance	0 dB	to	100 dB	1 mV	to	5 V	20 Hz	to	3 MHz	0.5dB
LBAL	Longitudinal Balance	0 dB	to	100 dB	1 mV	to	5 V	20 Hz	to	3 MHz	0.5dB
ILOS	Insertion Loss	-100 dB	to	100 dB	1 mV	to	5 V	20 Hz	to	3 MHz	0.5dB
RESP	Frequency Response	-100 dB	to	100 dB	1 mV	to	5 V	20 Hz	to	3 MHz	1.0dB
RLOS	Return Loss	-100 dB	to	100 dB	1 mV	to	5 V	20 Hz	to	3 MHz	
Z	Impedance	1 mOhm	to	1 MOhm	1 mV	to	5 V	20 Hz	to	3 MHz	0.20%
ZB	Impedance + Bias	1 mOhm	to	1 MOhm	1 mV	to	5 V	20 Hz	to	3 MHz	0.20%
ANGL	Impedance Phase	-360°	to	360°	1 mV	to	5 V	20 Hz	to	3 MHz	0.05°
PHAS	Inter-winding Phase	-360°	to	360°	1 mV	to	5 V	20 Hz	to	3 MHz	0.05°

10.1.2. High Voltage Tests

Test	Name	Measurement Range			Test Signal			Test Frequency			A _R ⁽¹⁾
HPAC	AC Hi-Pot	1 uA	to	30 mA (4)	100 V	to	5 kV	50 Hz	to	1 kHz	3.00%
HPDC	DC Hi-Pot	1 uA	to	3 mA	100 V	to	7 kV				3.20%
SURG	Surge Stress	1 mVs	to	1 kVs	100 V	to	5 kV				3.00%
IR	Insulation Resist.	100 kOhm	to	100 GOhm	100 V	to	7 kV				1.00%
ILK	Leakage Current	1 uA	to	10 mA	1 V	to	270 V	20 Hz	to	1 kHz	0.50%
MAGI	Magnetizing Current	1 mA	to	2 A (3)	1 V	to	270 V 40 W	20 Hz	to	1.5 kHz	0.10%
VOC	Open Circuit Voltage	100 mV	to	650 V (3)	1 V	to	270 V 40 W	20 Hz	to	1.5 kHz	0.10%
WATT	Wattage	1 mW	to	40 W	1 V	to	270 V 40 W	20 Hz	to	1.5 kHz	0.30%
STRW	Stress Wattage	1 mW	to	40 W	1 V	to	270 V 40 W	20 Hz	to	1.5 kHz	1.00%
PWRF	Power Factor	0	to	1	1 V	to	270 V 40 W	20 Hz	to	1.5 kHz	0.5%

10.1.3. DC1000 + DC1000A Tests

Test	Name	Measurement Range			Test Signal			Test Frequency			A _R ⁽¹⁾
LSBX	Series Inductance + DC1000 Bias	1 nH	to	1 MH	1 mV	to	5 V	20 Hz	to	3 MHz	0.05%
LPBX	Parallel Inductance + DC1000 Bias	1 nH	to	1 MH	1 mV	to	5 V	20 Hz	to	3 MHz	0.05%
ZBX	Impedance +DC1000 Bias	1 mOhm	to	1 MOhm	1 mV	to	5 V	20 Hz	to	3 MHz	0.20%

10.1.4. AC Interface Tests

Test	Name	Measurement Range			Test Signal			Test Frequency			A _R ⁽¹⁾
MAGX	Magnetizing Current (Ext Source)	50 mA	to	10 A (6)	1 V	to	600 V	20 Hz	to	5 kHz (2)	0.10%
VOCX	Open Circuit Voltage (Ext Source)	100 mV	to	650 V (6)	1 V	to	600 V	20 Hz	to	5 kHz (2)	0.10%
WATX	Wattage (Ext. Source)	100 mW	to	6 kW (6)	1 V	to	600 V	20 Hz	to	5 kHz (2)	1.00%
STRX	Stress Wattage (Ext. Source)	100 mW	to	6 kW (6)	1 V	to	600 V	20 Hz	to	5 kHz (2)	1.00%

Notes:

- 1 A_R = the basic relative accuracy (see later for the full specification).
- 2 Depends on external source type.
- 3 650 Vrms for AC measurements, or 900 V for DC measurements.
40 W MAX for VOC / MAGI /WATT / STRW
- 4 Peak value
- 5 DC bias current accuracy is +/-10% of the requested value.
- 6 40 W when using ACIF with step up/step down Transformer.
6 kW Max when using ACIF with external AC power amplifier
(choice of amplifier may give a lower max power)

Please note : The WATX and STRX tests are a function of the voltage and magnetising current on the energised winding , and so are also only valid if voltage > 100mv AND current is >50mA as per MAGX, even if you are just performing the WATX/STRX test.

Test Frequency Accuracy

- | | |
|-------------------------|--|
| F <= 16 kHz | error is +/-0.25Hz +/- 0.01% of requested frequency. |
| F >16 kHz and <= 250kHz | error is +/- 4Hz +/- 0.01% of requested frequency. |
| F > 250 kHz | error is +/- 64 Hz +/- 0.01% of requested frequency. |

Signal Level Accuracy

- | | |
|----------|---|
| Voltage | +/- 1mV +/- (2.5% +/- 0.01% / kHz) of test signal. |
| Current: | +/- 100 uA +/- (2.5% +/- 0.01% / kHz) of test signal. |

Tests in BOLD

- | | |
|----------------------------|----------------------------------|
| MAGX VOCX WATX STRX | - for use with AC INTERFACE. |
| LSBX LPBX ZBX | - for use with DC1000 / DC1000A. |

10.2. Accuracy Specifications – Available Tests

10.2.1. R Test

The accuracy is based on the chosen test conditions, and is given by:

$$A_T = A_R + A_C + A_V + A_I$$

where:

A_T is the total accuracy (%)

A_R is the basic relative accuracy (%)

A_C is the calibration accuracy (%)

A_V is the correction for voltage level (%)

A_I is the correction for current level (%)

where:

$$A_R = 0.10\%$$

$$A_C = 0.08\%$$

$$A_V = 0.03\% + \frac{0.1\%}{V_M}$$

$$A_I = 0.03\% + \frac{0.001\%}{I_M}$$

where:

V_M is the measured voltage (V)

I_M is the measured current (A)

The test signal is set according to the value specified as maximum in the test limits: -

Maximum Resistance R	<1Ω	1Ω-10kΩ	10kΩ-50kΩ	>50kΩ
Test current	I=1	I=1/R	V=R*100u	V=5

Where:

V = Volts (V)

I = Current (A)

R = Resistance (Ω)

10.2.2. LS, LP, RLS, RLP, LL and C Tests

The accuracy is based on the chosen test conditions, and is given by:

$$A_T = A_R + A_C + A_V + A_I + A_Q$$

where:

- A_T is the total accuracy (%)
- A_R is the basic relative accuracy (%)
- A_C is the calibration accuracy (%)
- A_V is the correction for voltage level (%)
- A_I is the correction for current level (%)
- A_Q is the correction for Q factor (%)

where:

$$A_R = 0.05 \% \text{ for LS LP RLS RLP, or } 0.1\% \text{ for LL, C}$$

$$A_C = 0.08 \% + (0.0000 1\% * F_M)$$

$$A_V = 0.08 \% + \frac{0.02 \%}{V_M}$$

$$A_I = 0.08 \% + \frac{0.0001 \%}{I_M}$$

$$A_Q = 0.08 \% + \frac{0.2 \%}{Q_M} \quad (\text{For LS, LP, LL \& C})$$

$$A_Q = 0.08 \% + (0.2 \% * Q_M) \quad (\text{For RLS \& RLP})$$

where:

- F_M is the test frequency (Hz)
- V_M is the measured voltage (V)
- I_M is the measured current (A)
- Q_M is the measured Q factor.

10.2.3. QL and D Tests

The accuracy is based on the chosen test conditions, and is given by:

$$A_T = A_R + A_I + A_{QD}$$

where:

A_T is the total accuracy (%)

A_R is the basic relative accuracy (%)

A_I is the correction for current level (%)

A_{QD} is the correction for Q or D factor (%)

where:

$$A_R = 0.50 \%$$

$$A_I = 0.08 \% + \frac{0.0001 \%}{I_M}$$

$$A_{QD} = 0.2 \% * [Q_M + (\frac{1}{Q_M})] \text{ (For Q factor)}$$

$$A_{QD} = 0.2 \% * [D_M + (\frac{1}{D_M})] \text{ (For D factor)}$$

where:

I_M is the measured current (A)

Q_M is the measured Q factor.

D_M is the measured D factor.

10.2.4. TR Test

The accuracy is based on the chosen test conditions, and is given by:

$$A_T = A_R + A_C + A_{PV} + A_{SV} + A_N$$

where:

A_T is the total accuracy (%)

A_R is the basic relative accuracy (%)

A_C is the calibration accuracy (%)

A_{PV} is the correction for primary voltage level (%)

A_{SV} is the correction for secondary voltage level (%)

A_N is the correction for the turns ratio (%)

where:

$$A_R = 0.1 \%$$

$$A_C = 0.1 \% + (0.00001 \% * F_M)$$

$$A_{PV} = 0.1 \% + \left(\frac{0.01 \%}{V_{PM}} \right)$$

$$A_{SV} = 0.1 \% + \left(\frac{0.01 \%}{V_{SM}} \right)$$

$$A_N = 0.1 \% + \left(\frac{0.1 \%}{N_M} \right)$$

where:

F_M is the test frequency (Hz)

V_{PM} is the measured primary voltage (V)

V_{SM} is the measured secondary voltage (V)

N_M is the measured turns ratio (Primary/Secondary)

10.2.5. TRL Test

The accuracy is based on the chosen test conditions, and is given by:

$$A_T = A_{LSP} + A_{LSS}$$

where:

A_T is the total accuracy (%)

A_{LSP} is the accuracy of the primary inductance (%)

A_{LSS} is the accuracy of the secondary inductance (%)

To calculate the accuracies of the primary and secondary inductances, use the formula for LS accuracy given in 10.2.2.

10.2.6. MAGI Test

The accuracy of the applied test voltage is 1%.

The measurement accuracy of MAGI is based on the chosen test conditions, and is given by:

$$A_T = A_R + A_C + A_I$$

where:

A_T is the total accuracy (%)

A_R is the basic relative accuracy (%)

A_C is the calibration accuracy (%)

A_I is the correction for current level (%)

where:

$$A_R = 0.10 \%$$

$$A_C = 0.08 \% + (0.001 \% * F_M)$$

$$A_I = 0.03 \% + \left(\frac{0.01 \%}{I_M}\right) + (2.0 \% * I_M)$$

where:

F_M is the test frequency (Hz)

I_M is the measured current (A)

10.2.7. MAGX Test (External Source)

The accuracy is based on the chosen test conditions, and is given by:

$$A_T = A_R + A_C + A_I + A_{OFF} + A_{ESI} + A_{SRCE}$$

where:

A_T is the total accuracy (%)

A_R is the basic relative accuracy (%)

A_C is the calibration accuracy (%)

A_I is the correction for current level (%)

A_{OFF} is the error in the compensation measurement (%)

A_{ESI} is the error in the source interface current (%)

A_{SRCE} is the correction for external source type (%)

where:

$$A_R = 0.10 \%$$

$$A_C = 0.08 \% + (0.001 \% * F_M)$$

$$A_I = 0.03 \% + \left(\frac{0.01 \%}{I_M}\right) + (2.0 \% * I_M)$$

$$A_{OFF} = [0.23 \% + (0.0003 \% * F_M)] * \frac{1}{I_M}$$

$$A_{ESI} = 0.5 \%$$

$$A_{SRCE} = 0.5\% \text{ (For manual or line supply)}$$

$$A_{SRCE} = 0.0\% \text{ (For analog, amplifier or AT output tx)}$$

where:

F_M is the test frequency (Hz)

I_M is the measured current (A)

During a MAGX test the AT5600 automatically applies the test voltage to the part under test and checks that the voltage has stabilized before recording measurements.

The time that the voltage takes to stabilize will vary with the source type used and the nature of the part under test.

In general, (and especially for source types 'Programmable' and 'AT Output Transformer'), the AT5600 will record a measurement very quickly, (typically in less than 0.5 seconds) which is desirable in a production test environment.

If the measurement were to be recorded after a longer period under power, slightly different readings may be obtained due to self-heating effects in the part under test. This effect may be noticed when comparing results taken using different source types or with slower measurement systems.

10.2.8. VOC Test

The accuracy of the applied test voltage is 1%.

The measurement accuracy is based on the chosen test conditions, and is given by:

$$A_T = A_R + A_C + A_V$$

where:

A_T is the total accuracy (%)

A_R is the basic relative accuracy (%)

A_C is the calibration accuracy (%)

A_V is the correction for voltage level (%)

where:

$$A_R = 0.10 \%$$

$$A_C = 0.08 \% + (0.001 \% * F_M)$$

$$A_V = 0.03 \% + \left(\frac{0.01 \%}{V_M}\right)$$

where:

F_M is the test frequency (Hz)

V_M is the measured voltage (V)

10.2.9. VOCX Test (External Source)

The accuracy is based on the chosen test conditions, and is given by:

$$A_T = A_R + A_C + A_V + A_{SRCE}$$

where:

A_T is the total accuracy (%)

A_R is the basic relative accuracy (%)

A_C is the calibration accuracy (%)

A_V is the correction for voltage level (%)

A_{SRCE} is the correction for external source type (%)

where:

$$A_R = 0.10 \%$$

$$A_C = 0.08 \% + (0.001 \% * F_M)$$

$$A_V = 0.03 \% + \left(\frac{0.01 \%}{V_M} \right)$$

$$A_{SRCE} = 0.5 \% \text{ (For manual or line supply)}$$

$$A_{SRCE} = 0.0 \% \text{ (For analog, amplifier or AT output tx)}$$

where:

F_M is the test frequency (Hz)

V_M is the measured voltage (V)

During a VOCX test the AT5600 automatically applies the test voltage to the part under test and checks that the voltage has stabilized before recording measurements.

The time that the voltage takes to stabilize will vary with the source type used and the nature of the part under test.

In general, (and especially for source types 'Programmable' and 'AT Output Transformer'), the AT5600 will record a measurement very quickly, (typically in less than 0.5 seconds) which is desirable in a production test environment.

If the measurement were to be recorded after a longer period under power, slightly different readings may be obtained due to self-heating effects in the part under test.

This effect may be noticed when comparing results taken using different source types or with slower measurement systems.

10.2.10. LVOC Test

The accuracy is based on the chosen test conditions, and is given by:

$$A_T = A_R + A_C + A_V$$

where:

A_T is the total accuracy (%)

A_R is the basic relative accuracy (%)

A_C is the calibration accuracy (%)

A_V is the correction for voltage level (%)

where:

$$A_R = 0.10 \%$$

$$A_C = 0.08 \% + (0.00001 \% * F_M)$$

$$A_V = 0.03 \% + \left(\frac{0.01 \%}{V_M}\right)$$

where:

F_M is the test frequency (Hz)

V_M is the measured voltage (V)

10.2.11. IR Test

The accuracy of the test voltage is 3% +/-50V.

The accuracy is based on the chosen test conditions, and is given by:

$$A_T = A_R + A_C + A_I + A_Z$$

where:

- A_T is the total accuracy (%)
- A_R is the basic relative accuracy (%)
- A_C is the calibration accuracy (%)
- A_I is the correction for current level (%)
- A_Z is the correction for impedance (%)

where:

$$A_R = 1.00 \%$$

$$A_C = 0.08 \%$$

$$A_I = 3.20 \% + \left(\frac{0.000002 \%}{I_M} \right)$$

$$A_Z = 0.5 \% + (0.001 \% * Z_M)$$

where:

- I_M is the measured current (A)
- Z_M is the measured IR value (M Ω)

10.2.12. HPDC Test

The accuracy of the test voltage is 3% +/-50V.

The accuracy of the measured current is based on the chosen test conditions, and is given by:

$$A_T = A_R + A_C + A_I$$

where:

A_T is the total accuracy (%)

A_R is the basic relative accuracy (%)

A_C is the calibration accuracy (%)

A_I is the correction for current level (%)

where:

$$A_R = 3.20 \%$$

$$A_C = 0.08 \%$$

$$A_I = \frac{0.0001 \%}{I_M}$$

where:

I_M is the measured current (A)

10.2.13. HPAC Test

The accuracy of the test voltage is 3% +/-50V.

The accuracy of the measured current is based on the chosen test conditions, and is given by:

$$A_T = A_R + A_C + A_I$$

where:

A_T is the total accuracy (%)

A_R is the basic relative accuracy (%)

A_C is the calibration accuracy (%)

A_I is the correction for current level (%)

where:

$$A_R = 3.00 \%$$

$$A_C = 0.08 \% + 0.001 \% * F_m$$

$$A_I = \frac{0.001 \%}{I_M}$$

where:

I_M is the measured current (A)

F_M is the test frequency (Hz)

10.2.14. LSB AND LPB Tests

The accuracy is based on the chosen test conditions, and is given by:

$$A_T = A_R + A_C + A_V + A_I + A_Q$$

where:

- A_T is the total accuracy (%)
- A_R is the basic relative accuracy (%)
- A_C is the calibration accuracy (%)
- A_V is the correction for voltage level (%)
- A_I is the correction for current level (%)
- A_Q is the correction for Q factor (%)

where:

$$A_R = 0.05 \%$$

$$A_C = 0.08 \% + (0.00001 \% * F_M)$$

$$A_V = 0.08 \% + \left(\frac{0.02 \%}{V_M} \right)$$

$$A_I = 0.08 \% + \left(\frac{0.0001 \%}{I_M} \right) + [0.03 \% * \left(\frac{I_B}{I_M} \right)]$$

$$A_Q = 0.08 \% + \left(\frac{0.2 \%}{Q_M} \right)$$

where:

- F_M is the test frequency (Hz)
- V_M is the measured voltage (V)
- I_M is the measured current (A)
- I_B is the bias current (A)
- Q_M is the measured Q factor.

10.2.15. WATT and STRW Tests

The accuracy of the applied test voltage is 2%. The measurement accuracy is based on the chosen test conditions, and is given by:

$$A_T = A_R + A_C + A_V + A_I + A_{PF}$$

where:

- A_T is the total accuracy (%)
- A_R is the basic relative accuracy (%)
- A_C is the calibration accuracy (%)
- A_V is the correction for voltage level (%)
- A_I is the correction for current level (%)
- A_{PF} is the correction for power factor (%)

where:

$$A_R = 0.30 \% \text{ for WATT or } 1.00 \% \text{ for STRW}$$

$$A_C = 0.80 \% + \left(\frac{0.001 \%}{F_M} \right)$$

$$A_V = 0.05 \% + \left(\frac{0.01 \%}{V_M} \right)$$

$$A_I = 0.05 \% + \left(\frac{0.01 \%}{I_M} \right) + (1.0 \% * I_M)$$

$$A_{PF} = 1.0 \% * \left(\frac{\sqrt{(1 - PF^2)}}{PF} \right)$$

where:

- F_M is the test frequency (Hz)
- V_M is the measured voltage (V)
- I_M is the measured current (A)
- PF is the power factor of the load.

and:

$$PF = \frac{W}{VA}$$

where:

- W is the measured power (W)
- VA is the product of test voltage and magnetizing current.

10.2.16. WATX and STRX Tests (External Source)

The measurement accuracy is based on the chosen test conditions, and is given by:

$$A_T = A_{MAGX} + A_{VOCX} + A_{PF}$$

where:

A_T is the total accuracy (%)

A_{MAGX} is the accuracy of the MAGX current measurement (%)

A_{VOCX} is the accuracy of the VOCX voltage measurement (%)

A_{PF} is the correction for power factor (%)

The accuracies of the MAGX and VOCX measurements are computed from the formulae in 10.2.7 and 10.2.9.

$$A_{PF} = [1.0\% + (0.001 \% * F_M)] * \frac{\sqrt{1 - PF^2}}{PF}$$

where:

F_M is the test frequency (Hz)

PF is the power factor of the load.

and:

$$PF = \frac{W}{VA}$$

where:

W is the measured power (W)

VA is the product of MAGX and VOCX results.

When performing either of these tests, the AT5600 automatically applies the test voltage to the part under test and checks that the voltage has stabilized before recording measurements. The time that the voltage takes to stabilize will vary with the source type used and the nature of the part under test.

In general, (and especially for source types 'Programmable' and 'AT Output Transformer'), the AT5600 will record a measurement very quickly, (typically in less than 0.5 seconds) which is desirable in a production test environment.

If the measurement were to be recorded after a longer period under power, slightly different readings may be obtained due to self-heating effects in the part under test. This effect may be noticed when comparing results taken using different source types or with slower measurement systems.

10.2.17. SURG Test

The measurement accuracy is based on the chosen test conditions, and is given by:

$$A_T = A_R + A_C + A_V$$

where:

A_T is the total accuracy (%)

A_R is the basic relative accuracy (%)

A_C is the calibration accuracy (%)

A_V is the correction for voltage level (%)

where:

$$A_R = 3.00 \%$$

$$A_C = 3.00 \%$$

$$A_V = 2.0 \% + \left(\frac{250 \%}{V_P}\right) + (0.001 \% * V_P)$$

where:

V_P is the programmed peak voltage (V)

10.2.17.1 Max programmable SURG voltage

For UUTs with $L_s \Rightarrow 125\mu\text{H}$, the unit maximum is achievable, namely 5000V DC

For UUTs with $L_s \leq 125\mu\text{H}$, the maximum voltage achievable is defined by

$$V_{out} = (7000 * L_{uut}) / (L_{uut} + 50)$$

where L_{uut} = UUT Series Inductance in μH

This reduction is because there is a 50 μH inductor in the AT5600 to protect the unit in the case that the SURGE is discharged into a dead short.

The above limitation can be seen expressed on the below graph.

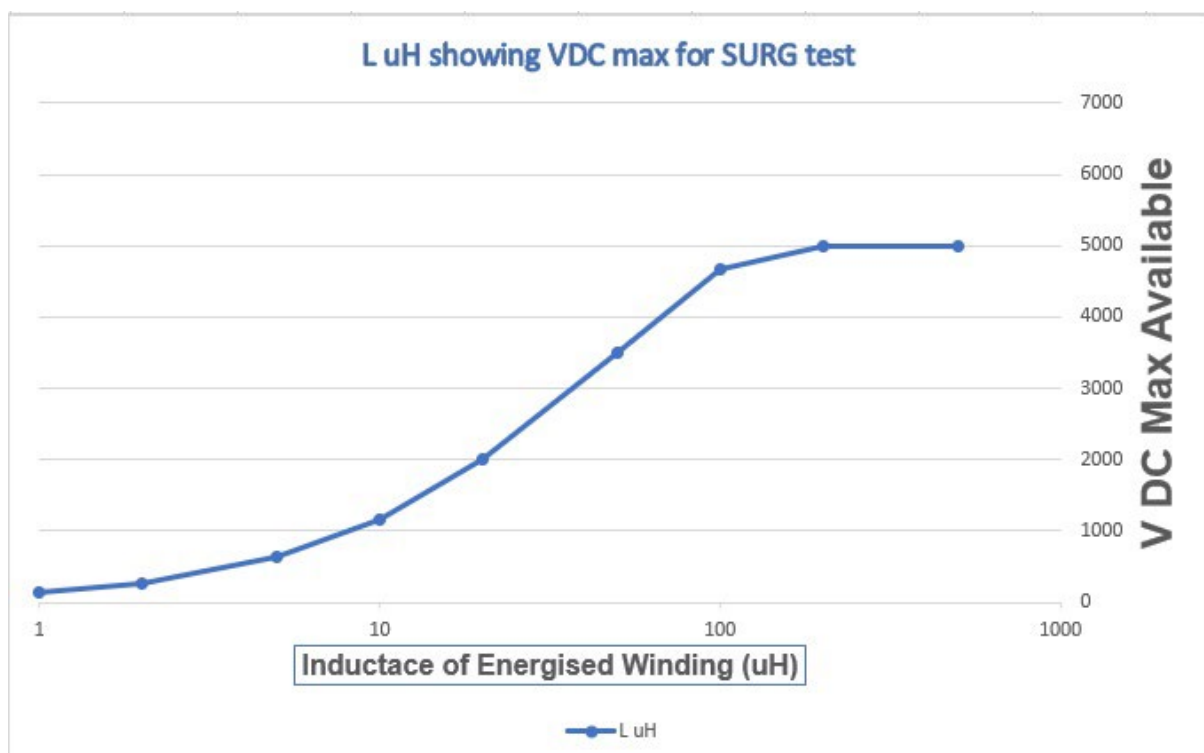

10.2.18. L2, C2 and R2 Tests

The accuracy is dependent on the accuracy of the two inductance, capacitance or resistance measurements made, and is given by:

$$A_T = A_X + A_Y$$

where:

A_T is the total accuracy (%)

A_X is the accuracy of the X measurement (%)

A_Y is the accuracy of the Y measurement (%)

Refer to the accuracy specifications for the LS, C and R tests to determine the accuracy of the X and Y measurements (10.2.2 and 10.2.1) and simply add them together.

10.2.19. GBAL Test

The measurement accuracy is based on the chosen test conditions, and is given by

$$A_T = A_R + 0.87(A_C + A_{VI} + A_{VO})$$

where:

- A_T is the total accuracy (dB)
- A_R is the basic relative accuracy.
- A_C is the calibration accuracy.
- A_{VI} is the correction for the input voltage level.
- A_{VO} is the correction for the output voltage level.

where:

$$A_R = 0.5 \text{ dB}$$

$$A_C = 0.1 + (0.000001 * F_M) \text{ dB}$$

$$A_{VI} = \frac{0.01 \text{ dB}}{V_{MI}}$$

$$A_{VO} = \frac{0.01 \text{ dB}}{V_{MO}}$$

where:

- F_M is the test frequency (Hz)
- V_{MI} is the measured input voltage (V)
- V_{MO} is the measured output voltage (V)

10.2.20. LBAL and ILOS Tests

The measurement accuracy is based on the chosen test conditions, and is given by:

$$A_T = A_R + 0.87(A_C + A_{VI} + A_{VO})$$

where:

A_T is the total accuracy (dB)

A_R is the basic relative accuracy.

A_C is the calibration accuracy.

A_{VI} is the correction for the input voltage level.

A_{VO} is the correction for the output voltage level.

where:

$$A_R = 0.5 \text{ dB}$$

$$A_C = 0.1 + (0.000001 * F_M) \text{ dB}$$

$$A_{VI} = \frac{0.01 \text{ dB}}{V_{MI}}$$

$$A_{VO} = \frac{0.01 \text{ dB}}{V_{MO}}$$

where:

F_M is the test frequency (Hz)

V_{MI} is the measured input voltage (V)

V_{MO} is the measured output voltage (V)

10.2.21. RESP Test

The measurement accuracy is based on the chosen test conditions, and is given by:

$$A_T = A_R + 1.74(A_C + A_{VI} + A_{VO})$$

where:

A_T is the total accuracy (dB)

A_R is the basic relative accuracy (dB)

A_C is the calibration accuracy.

A_{VI} is the correction for the input voltage level.

A_{VO} is the correction for the output voltage level.

where:

$$A_R = 1.0 \text{ dB}$$

$$A_C = 0.1 + (0.000001 * F_M) \text{ dB}$$

$$A_{VI} = \frac{0.01 \text{ dB}}{V_{MI}}$$

$$A_{VO} = \frac{0.01 \text{ dB}}{V_{MO}}$$

where:

F_M is the test frequency (Hz)

V_{MI} is the measured input voltage (V)

V_{MO} is the measured output voltage (V)

10.2.22. RLOS Test

The measurement accuracy is based on the chosen test conditions, and is given by:

$$A_T = 0.174 \frac{(Z_R * Z)}{(Z_R^2 - Z^2)} * A_Z$$

where:

A_T is the total accuracy (dB)

A_Z is the total accuracy of the Z test (%)

$$Z = \frac{V_M}{I_M}$$

$$Z_R = \sqrt{Z_{real}^2 + Z_{imag}^2}$$

and:

V_M is the measured voltage (V)

I_M is the measured current (A)

Z_{real} is the real part of the reference impedance (Ω)

Z_{imag} is the imaginary part of the reference impedance (Ω)

10.2.23. Z and ZB Test

The accuracy is based on the chosen test conditions, and is given by:

$$A_T = A_R + A_C + A_V + A_I$$

where:

A_T is the total accuracy (%)

A_R is the basic relative accuracy (%)

A_C is the calibration accuracy (%)

A_V is the correction for voltage level (%)

A_I is the correction for current level (%)

where:

$$A_R = 0.20 \%$$

$$A_C = 0.08 \% + (0.00001 \% * F_M)$$

$$A_V = 0.08 \% + \left(\frac{0.02 \%}{V_M} \right)$$

$$A_I = 0.08 \% + \left(\frac{0.0001 \%}{I_M} \right) + [0.03 \% * \left(\frac{I_B}{I_M} \right)]$$

where:

F_M is the test frequency (Hz)

V_M is the measured voltage (V)

I_M is the measured current (A)

I_B is the bias current (A)

10.2.24. ANGL Test

The accuracy is based on the chosen test conditions, and is given by:

$$A_T = A_R + A_C + A_V + A_I$$

where:

A_T is the total accuracy (°)

A_R is the basic relative accuracy (°)

A_C is the calibration accuracy (°)

A_V is the correction for voltage level (°)

A_I is the correction for current level (°)

where:

$$A_R = 0.05 \text{ deg.}$$

$$A_C = 0.03 + (0.0000025 * F_M) \text{ deg.}$$

$$A_V = 0.03 + \frac{0.01}{V_M}$$

$$A_I = 0.03 + \frac{0.000003}{I_M}$$

where:

F_M is the test frequency (Hz)

V_M is the measured voltage (V)

I_M is the measured current (A)

10.2.25. PHAS Test

The accuracy is based on the chosen test conditions, and is given by:

$$A_T = A_R + A_C + A_V + A_N$$

where:

- A_T is the total accuracy (°)
- A_R is the basic relative accuracy (°)
- A_C is the calibration accuracy (°)
- A_V is the correction for voltage level (°)
- A_N is the correction for turns ratio (°)

where:

$$A_R = 0.05 \text{ deg}$$

$$A_C = 0.3 \text{ deg} + (0.000005 * F_M) \text{ deg}$$

$$A_V = 0.05 * \left(\frac{1}{V_P} + \frac{TR}{V_P} \right) \text{ deg}$$

$$A_N = 0.05 * \left(\left| V_P - \frac{V_P}{TR} \right| \right) \text{ deg}$$

where:

- F_M is the test frequency (Hz)
- V_P is the measured primary voltage (V)
- TR is the turns ratio between the primary and secondary.

10.2.26. ILK Test

The accuracy is based on the chosen test conditions, and is given by:

$$A_T = A_R + A_C + A_I$$

where:

A_T is the total accuracy (%)

A_R is the basic relative accuracy (%)

A_C is the calibration accuracy (%)

A_I is the correction for current level (%)

where:

$$A_R = 0.5 \%$$

$$A_C = 0.1 \% + (0.001 \% * F_M)$$

$$A_I = 0.1 \% + \left(\frac{0.00001 \%}{I_M} \right)$$

where:

F_M is the test frequency (Hz)

I_M is the measured current (A)

10.2.27. LSBX and LPBX Tests

The accuracy is based on the chosen test conditions, and is given by:

$$A_T = A_R + A_C + A_V + A_I + A_Q$$

where:

- A_T is the total accuracy (%)
- A_R is the basic relative accuracy (%)
- A_C is the calibration accuracy (%)
- A_V is the correction for voltage level (%)
- A_I is the correction for current level (%)
- A_Q is the correction for Q factor (%)

where:

$$A_R = 0.05 \%$$

$$A_C = 0.08 \% + (0.00001 \% * F_M)$$

$$A_V = 0.08 \% + \left(\frac{0.02 \%}{V_M} \right)$$

$$A_I = 0.08 \% + \left(\frac{0.0001 \%}{I_M} \right) + (0.03 \% * \left(\frac{I_B}{I_M} \right))$$

$$A_Q = 0.08 \% + \left(\frac{2.0 \%}{Q_M} \right)$$

where:

- F_M is the test frequency (Hz)
- V_M is the measured voltage (V)
- I_M is the measured current (A)
- I_B is the bias current (A) from DC1000
- Q_M is the measured Q factor.

10.2.28. ZBX Test

The accuracy is based on the chosen test conditions, and is given by:

$$A_T = A_R + A_C + A_V + A_I$$

where:

A_T is the total accuracy (%)

A_R is the basic relative accuracy (%)

A_C is the calibration accuracy (%)

A_V is the correction for voltage level (%)

A_I is the correction for current level (%)

where:

$$A_R = 0.20 \%$$

$$A_C = 0.08 \% + (0.00001 \% * F_M)$$

$$A_V = 0.08 \% + \left(\frac{0.02 \%}{V_M} \right)$$

$$A_I = 0.08 \% + \left(\frac{0.0001 \%}{I_M} \right) + (0.03 \% * \left(\frac{I_B}{I_M} \right))$$

where:

F_M is the test frequency (Hz)

V_M is the measured voltage (V)

I_M is the measured current (A) from DC1000

I_B is the bias current (A)

10.2.29. ACRT Test

This test has been withdrawn and is no longer supported

10.2.30. DCRT Test

This test has been withdrawn and is no longer supported

10.2.31. ACVB Test

This test has been withdrawn and is no longer supported

10.2.32. DCVB Test

This test has been withdrawn and is no longer supported

10.2.33. PWRF Test

The measurement accuracy is based on the chosen test conditions and power factor, and is given by:

$$A_t = A_r + A_c + A_v + A_i + A_{pf}$$

where:

- A_t is the total accuracy (%)
- A_r is the basic relative accuracy (%)
- A_c is the calibration accuracy (%)
- A_v is the correction for voltage level (%)
- A_i is the correction for current level (%)
- A_{pf} is the correction for power factor (%)

where:

$$A_r = 0.50 \%$$

$$A_c = 0.24 \% + (0.003 \% * F)$$

$$A_v = 0.08 \% + (0.02 \% / V)$$

$$A_i = 0.08 \% + (0.02 \% / I) + (3.00 \% * I)$$

$$A_{pf} = 1.00 \% * ((\text{SQRT}(1 - PF^2)) / PF)$$

where:

- F is the test frequency (Hz)
- V is the measured voltage (V)
- I is the measured current (A)
- PF is the power factor of the load.

10.3. Interface Specifications

10.3.1. Server Port

RS232 interface for connection to a PC server running the Voltech server software.

25-pin male D-type connector

Pin		Signal name	Pin	Signal name
1		Ground (Earth)	6	No connection
2	i/p	RX	7	0V
3	o/p	TX	8	No connection
4	i/p	CTS	...	
5	o/p	RTS	25	No connection

As RS232 is now a legacy protocol for communications, it is highly likely that customers using RS232 on the AT5600 will use a USB to RS232 converter to interface with your PC.

As the AT5600 generates high voltages and is commonly used in environments where high voltage and EMC noise is present, we recommend using an optically ISOLATED USB-RS232 converter.

Voltech recommends the STAR TECH converter.

Model # ICUSB232IS

See www.startech.com

This is 1 Port Industrial USB to RS232 Serial Adapter with 5KV Isolation and 15 KV ESD Protection

10.3.2. Auxiliary Port

RS232 interface for connection to a PC running the Voltech editor software.

9-pin male D-type connector

Pin		Signal name	Pin		Signal name
1		No connection	6		No connection
2	o/p	TX	7	i/p	CTS
3	i/p	RX	8	o/p	RTS
4		No connection	9		No connection
5		0V			

SEE ABOVE RECOMMENDATION (in 10.3.1) OF ISOLATED USB TO RS232 CONVERTER

10.3.3. Remote Port

TTL compatible interface for operation with various peripherals including foot switch, remote controller, and monitor output. Can be used with robotic systems for triggering test runs and reading back pass/fail status.

The remote port mirrors some of the user I/O to a 9-way D port

These are.

Inputs

RUN and STOP Mirrors the action of the two front panel buttons.

Outputs

BUSY When a test is being executed.

PASS or FAIL Indication after the test has run.

BEEP Mirrors the unit buzzer to a digital signal.

9-pin male D-type connector

Pin	Signal name	Pin	Signal name
1	o/p BEEP	6	o/p !BUSY / Bin0
2	o/p !PASS / Bin1	7	0V
3	i/p !RUN	8	0V
4	o/p !FAIL / BinStrb	9	i/p !STOP
5	+5V		

Signals with a name starting with ! are active Lo.

!RUN Input (Pin 3)

The !RUN input is an active Lo input with an internal pull-up resistor. In the execution of programs, it is equivalent to pressing the RUN key on the front panel.

To use this with a footswitch, wire the switch between this input and 0V.

!STOP Input (Pin 9)

The !STOP input is an active Lo input with an internal pull-up resistor.

The active-going edge of this input halts all AT5600 activity, turning off all signal sources.

To use this with an 'emergency stop' switch, wire the switch between this input and 0V.

BUSY / PASS / FAIL Status Outputs (Pins 2, 4 and 6)

The status outputs are standard 5 Volt logic signals.

In the standard set-up, the three status outputs are active Lo signals which signal Busy, Pass and Fail. They could, for example, be connected as status inputs to a robot controller, a bin selector, or indicator large lamps to show the status.

All the outputs are fitted with 1k Ω protection resistors, and therefore they cannot directly drive external high current loads such as indicators, or bin-select relays.

Note: The BUSY will remain active after a test program has been completed, but while SERVER comms are being used to send results data back to a PC. This can potentially be a few seconds on a slow PC over RS232.

Beep Output (Pin 1)

This is an active Hi output which mirrors the internal beeper.

Example – using footswitch with Remote Port.

A footswitch can be used to trigger a program RUN from the remote port.

This gives a simple foot pedal to trigger RUN on the AT5600 (also compatible with AT3600)

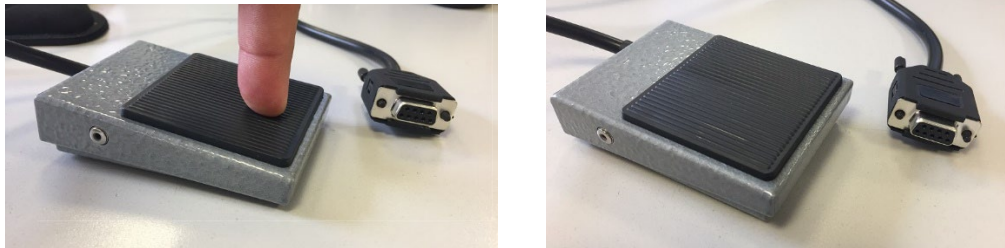

Voltech no longer supply this assembly, but the parts are freely available from the following places.

Footswitch Momentary and non-latching - RS components (RS# : 316-901) or HERGA 6289-CC (Farnell 422940 or NEWARK 06WX5562)

Suitable 9-way female plug – e.g., ITT CANNON ZDE9S (Newark 42M2693 or FARNELL 1348016).

Suitable 9 way back shell – e.g., ITT CANNON DE77762-9 - (Newark 25M8922 or Farnell 1215629)

Wiring

<u>Foot switch</u>	<u>9 way</u>
BLACK	pin 3
BROWN	pin 8
GREEN/YELLOW	Case of header for earth

Recommended isolated IC for REMOTE signal switching (if needed)

We recommend the COTORELAY C238S (or dual C338S) as a very well isolated IC that operates with the remote port drive signals but is still able to carry up to 80mA 600V on the switched side.

Manufacturer <https://cotorelay.com/>

Full data https://cotorelay.com/product/c238s_c338s_series_mosfetrelay/

10.3.4. Peripheral Interface

This interface is for connection only to an approved Voltech accessory.

Do not try to make other connections to this interface as damage may occur.

15-pin female D-type connector

Pin	Signal name	Pin	Signal name
1	o/p CC	9	o/p LP_HI
2	o/p LP_LO	10	No connection
3	o/p +12V	11	i/p AUXTRIP\
4	o/p ENAUX	12	No connection
5	o/p AUX_RELAY	13	0V(AUX)
6	0V(HP)	14	o/p HP_OUT
7	No connection	15	No connection
8	i/p AUX_IN		



HP_OUT Pin 14

DANGEROUS voltage up to 400V can be present on the HP_OUT pin when any attached safety device signals a safe condition.

General Signal Pins

Except for the HP_OUT pin, the other signals are either digital TTL type outputs or inputs, or connections through to the internal power supplies and signal generator sources.

10.3.5. Safety Interlock

There are 3 active circuits on the safety interlock connector.
Two are digital control circuits, and the third is a high voltage analog circuit.

See Section 6. of this manual for Important Safety Information

ALL three circuits must be correctly made before the AT5600 will run any tests.
Once the Safety interlock has been connected, the AT5600 can produce voltages that should be considered lethal.

9-pin female D-type connector

Pin	Signal name	Pin	Signal name
1	No connection	6	0V
2	+12V	7	i/p HVIP
3	o/p HVOP	8	No connection
4	No connection	9	i/p LB1
5	i/p !LB0		

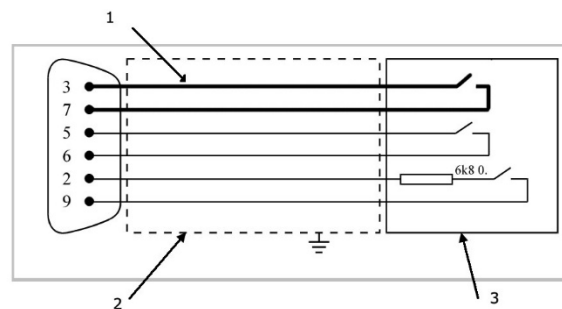

HVOP and HVIP (Pins 3 and 7)

The HVOP is an analog voltage output which can be as high as 400V.
The HVIP is a corresponding input voltage.

All the high voltage test signals used by the AT5600 are derived from this input. In the 'safe' condition HVOP is linked back into HVIP (PIN 3-7 Shorted)

LB0 and LB1 (Pins 5 and 9)

These are the two digital control signals.

When in the 'safe' condition, !LB0 is linked to 0V (pin5) , and LB1 is driven to a voltage between +4.5 V and +5V via a series 6k8 ohm, 0.4 W resistor.

In the 'safe' condition

Pin 5 should be shorted to pin 6

Pin 9 should be shorted to pin 2 via a 6k8 0.4W resistor

see 6.2.2 in this manual

This provides a triple redundant system for user safety.

10.3.6. User Port

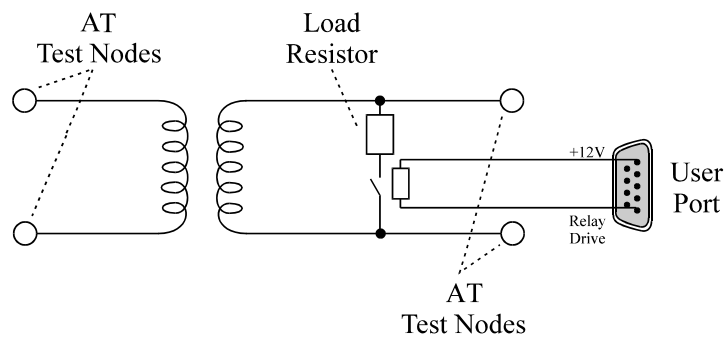

The User Port is positioned on the rear panel of the AT5600 and contains six open-collector relay drive outputs.

The relay drives are switched on and off by the OUT test, inserted into your test program sequence. This will enable you, for example, to switch a dummy load on to the secondary winding of the transformer under test, so that subsequent tests are performed on the loaded transformer.

The OUT test switches the control lines to the programmed levels in the following manner.

- 1 Open any relays changing to OFF
- 2 Wait 20 mSec
- 3 Close any relays switching to ON
- 4 Wait 20 mSec
- 5 proceeds to the next test.



BEWARE OF HIGH VOLTAGES

Remember when designing relays into your fixture that the AT5600 can produce extremely high voltages.

It is the responsibility of the user to ensure that both the relays themselves and the associated wiring can withstand any high voltage produced in the test program.

It is particularly important that YOU ensure that there is never a flash-over from a high voltage test signal to a relay coil driven from the User Port. Such a flash-over would cause extensive damage to the circuits inside the AT5600.

If in any doubt, contact your Voltech supplier for advice on which relay to use in your application.

9-pin female D-type connector

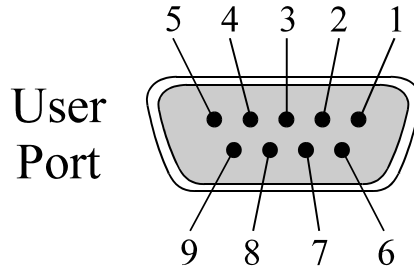

Pin	Signal name	Pin	Signal name
1	o/p User Relay 0 Drive	6	o/p User Relay 1 Drive
2	o/p User Relay 2 Drive	7	o/p User Relay 3 Drive
3	o/p User Relay 4 Drive	8	o/p User Relay 5 Drive
4	Not used	9	Not used
5	o/p +12V		

User Relay Drive Outputs (pins 1, 2, 3, 6, 7, 8)

All the User Relay Drive Outputs have the following equivalent circuit:

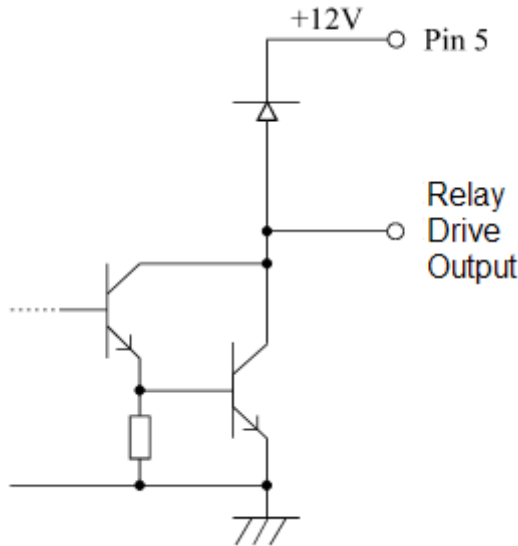

Specification:

- Relay coil resistance: > 150Ω
- Maximum output current: 80 mA per output

10.3.7. Ethernet Port

The Ethernet port is a standard RJ45 8P8C connector that provides a standard 10/100 Ethernet interface.

10.3.8. Front and Rear USB 'A' Ports

Standard USB 2.0 type 'A' interfaces used to connect the AT5600 to a printer.

Also supports USB Keyboard or USB Barcode reader meeting the HID-USB protocol

See website for details.

<https://www.voltech.com/applications/barcode-scanner-usb-hid/>

10.3.9. USB 'B' Port

A standard USB 2.0 type 'B' interface used to connect the AT5600 to a PC running the Voltech editor software.

10.4. Environmental Conditions

Line Input

IEC60320 3-pin C14 socket

Operating Voltage: 100 to 127VAC and 200 to 240VAC (Auto Changing)

Operating Frequency: 45 to 65 Hz

Input Power: 150 VA Maximum

Fuse 2 AT

Environment

EN61010-1, Pollution Degree 2, Installation Category II:

FOR INDOOR USE ONLY.

This ensures the safety of the instrument and the user when normal precautions are followed.

Dielectric Strength

1.5 KV AC 50Hz for 1 minute, line input to earth

Storage Temperature

-40°C to +70°C

Operating Temperature

+5°C to +40°C

As with any measuring equipment, the unit must be powered on for at least 30 minutes to become thermally stable, and SELF TEST run to confirm unit integrity.

Humidity

10% to 80% RH non-condensing

10.5. Mechanical

Weight: Approximately 18.5kg
Width: 432mm
Height: 199mm
Depth: 572mm

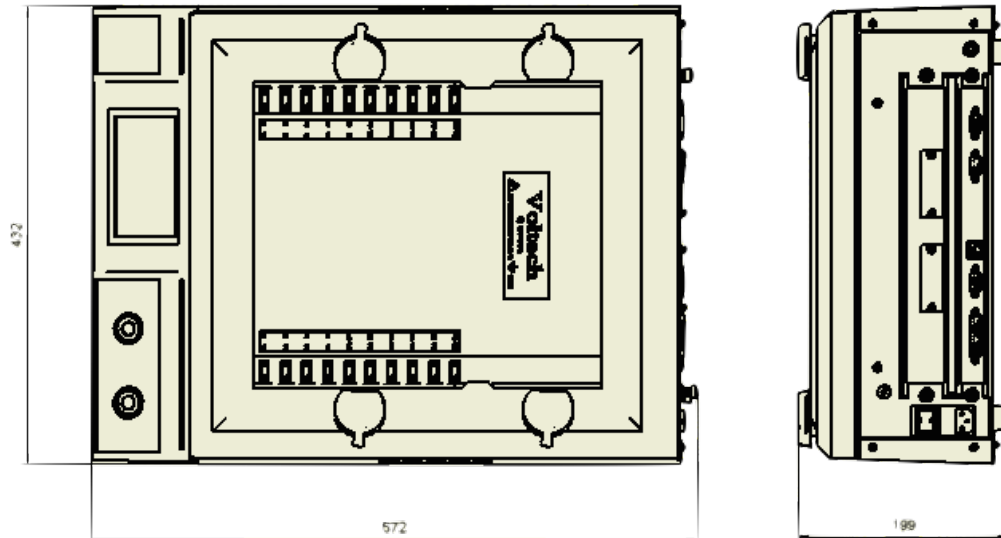

The fixture bay on the top surface of the AT5600 accepts Voltech fixture plates (see chapter 13).

The maximum static weight over a 100cm² area in the centre of a fixture is 5.0Kg

10.6. EMC Compliance

10.6.1. Declaration of Conformity

DECLARATION OF CONFORMITY

Manufacturers Name: Voltech Instruments
Manufacturers Address: Voltech Instruments, Ltd.
The Core Business Centre
Milton Hill, Abingdon
Oxfordshire
OX13 6AB
U.K.

declares that the product

Product Name: Wound Component Tester

Model Number: AT5600

conforms to the following product specifications

Safety: IEC 61010-1:2010 (3rd Edition)
Compliance with National Differences, US,EN,CA,JP,CH.

EMC: IEC 61326-1:2012, Class A, Table 1

Supplimentary Information:

The product herewith complies with the requirements of
the EMC Directive 2004/108/EC

And

the Low Voltage Directive 2006/95/EC

Signed for on behalf of Voltech Instruments



Dr John Ford, Managing Director

21 May 2014

11. Maintenance

Before performing any maintenance on the AT5600, always disconnect the AC line power supply cord and any peripherals.

11.1. Air Filters



The AT5600 houses two air filters that filter the air going through its cooling fans. These filters will be cleaned during a service and calibration (if returned to a Voltech service centre), and if done annually, this is normally enough to maintain the air flow through the instrument.

If the AT5600 is used in a particularly dusty environment, then the filters may become clogged and cause the unit to get too hot. If this happens then a warning message will be shown on the display and the filters will need cleaning.

To gain access to the filters, first remove the right-hand side panel as shown below.

11.1.1. Removing the right-hand side panel



Next unclip the filter retainers by pulling using fingers or a screwdriver to release the filters as shown.

11.1.2. Removing the air filters

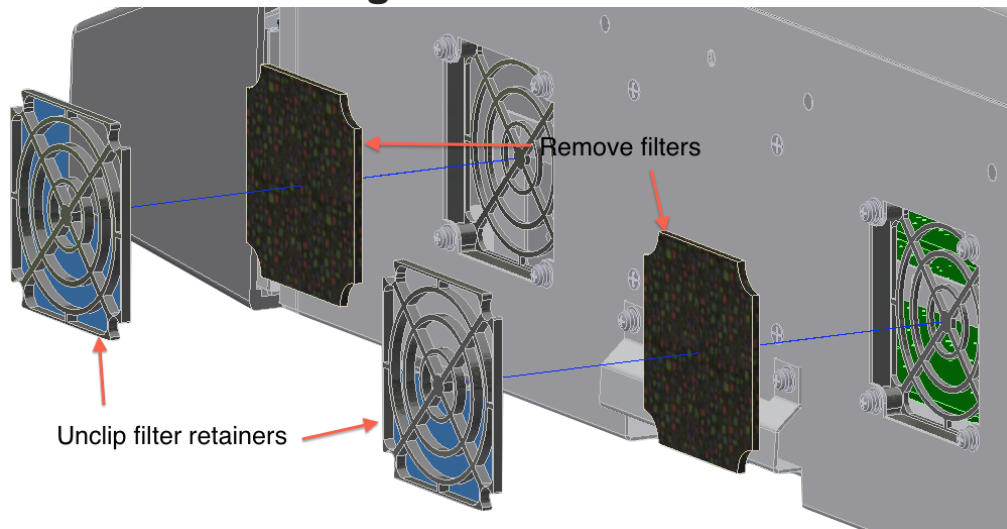

The filters can be cleaned with water or suction using a vacuum cleaner.

11.2. Test Probes

If any test probe gets damaged, they can be removed using needle nose pliers. Grasp the test probe firmly using the pliers and pull straight up. The 3 mm test probes are Ingun (UK) Ltd Part Number GK S113 204 300 R 1502.

The test pins on the bottom of the test fixture can also tarnish with age and accrue dirt and grease from the manufacturing environment. Voltech recommends Chemtronics Pow-R-Wash VZ for cleaning the test pins/
<https://www.chemtronics.com/pow-r-wash-vz>

11.3. Power Cords

Regularly check the power cord for any signs of wear and replace it if necessary.

11.4. Cleaning

Clean only using a damp cloth.

Do not use any cleaning chemicals as damage may occur to surfaces.

Do not allow water to run inside.

Ensure surfaces are thoroughly dry before use.

12. Warranty and Service

12.1. Warranty Information

12.1.1. Post-sale Warranty Agreement

The product is warranted free from material defects in workmanship and/or materials at the time of delivery to the Customer and that for a period of one year (12 months) from such time Voltech will repair or replace any Product which does not comply with this warranty PROVIDED ALWAYS THAT the Company's liability under this warranty shall be limited to the repair or replacement of affected Products and is conditional upon the Customer: -

1. Notifying the Company promptly of any such material defect and in any event within such period of one year.
2. Returning to the Company the affected Products properly and adequately packed, carriage or post-paid, within fourteen days of such notification
3. Having ensured that the Products have not been tampered with, repaired, modified, or altered in any way; and
4. Ensuring that the Products are protected from harm or otherwise properly cared for and are retained in the possession of the Purchaser.

In the event of a failure as above Voltech will

1. At its discretion, repair or replace the faulty unit free-of-charge for a unit returned to an authorized service centre
2. Pay all return shipment charges from the Voltech service centre to the customer.
3. Re-calibrate the unit before dispatch. A certificate of calibration will be issued as a matter of course.

LIMITATION OF WARRANTY

The foregoing warranty shall not apply to defects resulting from unauthorized modification or misuse, or operation outside specification of instrument. No other warranty is expressed or implied.

Whilst every care has been taken in compiling the information in this publication Voltech Instruments cannot accept legal liability for any inaccuracies contained herein. Voltech Instruments has an intensive program of design and development which may well alter product specification and reserve the right to alter specification without notice and whenever necessary to ensure optimum performance from its product range.

It shall be deemed to exclude all other warranties and conditions whether express or implied and whether arising by common law statute or otherwise.

Voltech reserve the right to waive this benefit in any event where it is clear upon inspection that the cause of the failure is due to customer misuse.

Voltech will be the sole arbiter in these circumstances.

Because software is inherently complex and may not be completely free of errors, you are advised to verify your work. In no event, will Voltech be liable for direct, indirect, special, incidental, or consequential damages arising out of the use of or inability to use software or documentation, even if advised of the possibility of such damage. Voltech is not responsible for any lost profits or revenue, loss of use of software, loss of data, cost of substitute software, claims by third parties, or for other similar costs. In no case, shall Voltech liability exceed the amount of the license fee. (*Should this be purchase price*)

Current Full terms of business can be viewed on Voltech's website (www.voltech.com) by selecting "Terms of Business" at the bottom of the home page.

12.2. Service and Calibration

To confirm the accuracy of your product, a calibration check should be carried out every 12 months.

Calibration adjustment is carried out using OEM equipment and software systems. Adjustment can only be performed by an authorized Voltech service centre.

For details of calibration facilities and any other service request, please contact your supplier. Voltech strongly recommends that you discuss your service requirements with your supplier before service is needed. Extended warranty and full-service agreements may be available.

12.3. Accessories

If you require any cables, fixtures, or fuses in addition to those supplied with your AT5600, please contact your local Voltech supplier.

The Voltech part numbers for the parts supplied with your unit are given in the section 1.4 on page 17 of this manual.

Full list of available accessories

- USB Cable
- Aux port RS232 lead
- Server port RS232 lead
- AC Interface Fixture
- Fixture Kit
- DC1000
- Safety Interlock Y lead
- Foot switch
- Light Curtain
- Light curtain interface cable
- Air Filters
- Spring Probes
- Power Cord

The Voltech part number for the RS232 cable supplied with AT products that you can use to interface with the DC1000A is 77-015.

The safety interlock Y lead used for combining a safety system with a Voltech AT series tester is VPN 250-031.

To connect safety interlock out through to safety interlock in connections the 77-046 RS232 cable can be used.

13. Test Fixtures

Making connections to the AT5600

13.1. Introduction

This chapter is an introduction to the fixture system designed for use with the AT series testers. Comprehensive instructions and application guidance for the construction of your own custom fixtures, are supplied with every custom fixture kit. The full fixture system user manual part number 98-028 is available from the Voltech website.

The AT5600 can perform an extremely comprehensive series of tests on a wide variety of wound components. To utilize this capability fully it is recommended that test fixtures are constructed to suit each part to be tested.

Test fixtures are based on a fixture board containing connection pins. They provide the interface to the tester via the tester node pins allowing transformers to be quickly inserted and removed in a reliable manner taking full advantage of the high-speed testing capability of the AT5600.

It is important to use well-constructed test fixtures. These benefits include.

- minimizing operator fatigue
- ensuring optimum repeatability
- preventing unnecessary rejects
- increasing test throughput

13.2. The Voltech Fixture System

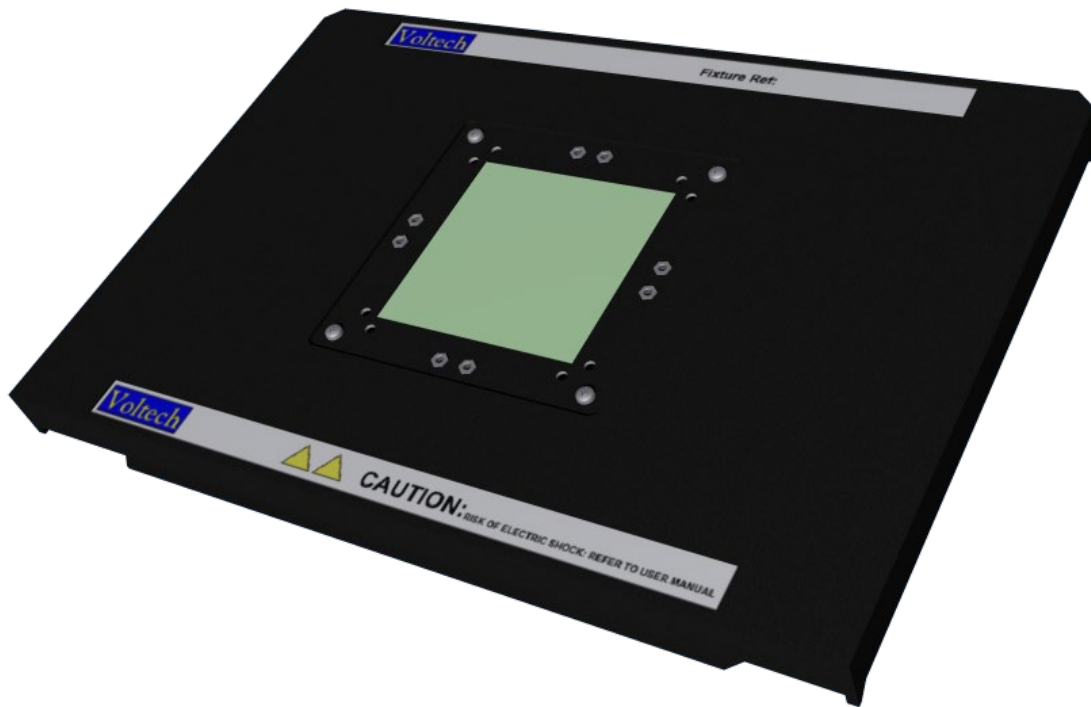

13.2.1. Description of the Fixture System

The Voltech AT Series fixture system allows you freedom and flexibility when considering your fixturing needs. All fixtures are mounted on fixture boards, which are available as a blank fixture plate and as a fixture kit which contains parts to help you. The fixture is designed to connect to wound components with the following characteristics:

Size:

- A footprint of up to 63.5 mm square
- A height of up to 63.5 mm
- A connection matrix up to 60 mm square
- A maximum static weight of 5.0Kg

Connection Types:

- Surface mount.
- Pin connection.
- Blade connection.
- Flying leads

Pitches of:

- 1.27 mm
- 1.96 mm (0.156")
- 2.00 mm
- 2.50 mm
- 2.54 mm (0.1")
- 3.81 mm (0.15")

Also, though a 1.27 mm pitch is available it is only anticipated that component connections will be on multiples of this pitch and there will not be two connections only 1.27 mm apart.

13.2.2. Compatible connection types

- Kelvin clips
- Kelvin blades (Automech type)
- 4mm sockets
- ATE pins (Rotary point, Castellated, Point, Cup, Crown)

A list of known suitable ATE pin types is shown in the fixture system user manual.

13.3. The Voltech 40 Socket Fixture

A fixture board fitted with 40 - 4mm sockets, 20 red (power) and 20 black (sense). The sockets are wired to the 40 contacts which align with the tester's 40 nodes.

This fixture may be used for convenient wiring to existing fixtures or as a means of connecting flying leads and clips for use in developing test programs or testing parts in a design laboratory.

13.4. Making Fixture Connections – Kelvin Connections

In testing many transformer parameters, such as winding resistance or inductance, it is necessary to measure electrical impedance.

The normal method of measuring impedance is to pass a test current through the unknown component, and to measure the resulting voltage produced across it. Dividing the voltage by the current gives the required value of impedance.

In making such measurements, great care must be taken not to include the impedance of the measuring leads in the result. A connection system that avoids such problems is shown below; it uses four wires and is often referred to as a Kelvin connection.

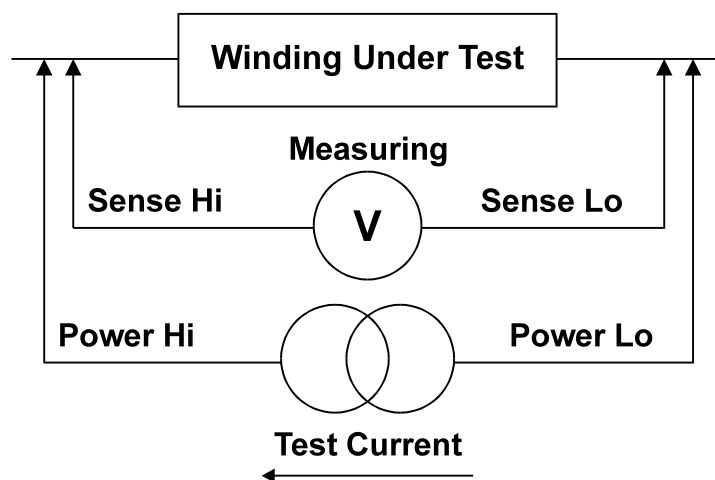

In this arrangement, the test current passes through the two 'power' leads, and the voltage is measured using the two 'sense' leads.

Provided that the sense leads are connected as close as possible to the body of the device under test, any additional voltage drop produced by the test current flowing through the impedance of the power leads is not measured.

The Kelvin connection therefore provides the most accurate means of sensing the voltage, and hence the impedance of the winding.

Ideally, all impedance measurements would be made using Kelvin connections. However, many terminals do not permit the use of four wires all the way to the body of the component under test.

In such cases, separate power and sense leads are used up to the base of the terminal and the length of 'common' lead (from the junction of the power and sense leads, through the terminal and the component lead to the body of the component) should be kept to a minimum.

The 'common' lead length is shown as AA' and BB' in the diagram below.

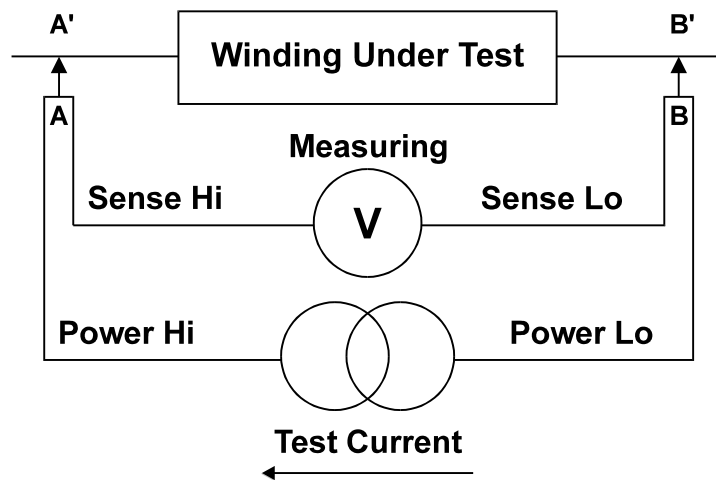

The AT series testers provide all the connections required to take advantage of Kelvin measurements.

A test node is a pair of connections consisting of one power and one sense terminal.

The following diagram indicates how to identify the node terminal function.

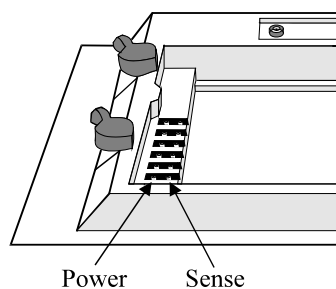

POWER terminals are all on the outside of the fixture area.
SENSE terminals are all on the inside of the fixture area.

IMPORTANT: Kelvin four terminal connections are generally advised to be used in all test fixtures but they are essential for impedance measurements less than 1Ω .

13.5. Compensation

Compensation of the test fixture is equivalent to short-circuit and open-circuit correction on a component analyser. It eliminates errors due to stray parasitic effects which are usually a combination of parallel capacitance between adjacent wires, sockets, or pins, and series resistance and inductance along the lengths of wires.

In addition to the open and short circuit correction, the AT5600 has been enhanced to provide load correction feature (for certain tests only), like high end LCR Meters, which allow you to perform load correction using a transfer function that determines the relationship between a standard reference value (pre-measured known value) and the standard's actual measurement. Load correction removes errors that cannot be compensated using open and short circuit correction.

Not all test programs require compensation, and for some programs containing only high-power tests, compensation is not possible.

It is best to try compensating when developing test programs with the Editor software. If compensation of the fixture changes the test results, then it should be applied whenever the program is run in a production situation.

When a program is first loaded on an AT5600, compensation must be performed, and the results are then stored for future use.

Compensation offsets are deliberately NOT stored in the program nor in the unit, as these offsets are characteristic of the total environment (program, fixture, and tester) as so would become confusing and ambiguous for users with several units and/or several fixtures.

For optimum accuracy, compensation measurements should be made.

- Whenever the test fixture is changed
- At the beginning of each day or work period
- Whenever a new test program is loaded into the AT for execution

Please see section 8.1.6.5 for details of the NEW "Automatic Compensation Storage" feature added in V1.002.000 of the firmware.

13.5.1. Compensation Summary – Available Tests

TEST		COMPENSATION AVAILABLE?		
Description	Mnemonic	S/C	O/C	Load (User choice)
Continuity	CTY	Yes	No	n/a
DC Resistance	R	Yes	No	Yes
DC Resistance Match	R2	Yes	No	Yes
Inductance (Series circuit)	LS	Yes	Yes	Yes
Inductance (Parallel circuit)	LP	Yes	Yes	Yes
Inductance Match	L2	Yes	Yes	Yes
Inductance with Bias (Series)	LSB	Yes	Yes	Yes
Inductance with Bias (Parallel)	LPB	Yes	Yes	Yes
Impedance with Bias	ZB	Yes	Yes	Yes
Inductance with Bias Series (DC1000)	LSBX	Yes	Yes	Yes
Inductance with Bias Parallel (DC1000)	LPBX	Yes	Yes	Yes
Impedance with Bias (DC1000)	ZBX	Yes	Yes	Yes
Quality Factor	QL	Yes	Yes	Yes
Dissipation Factor	D	Yes	Yes	Yes
Equivalent Series Resistance	RLS	Yes	Yes	Yes
Equivalent Parallel Resistance	RLP	Yes	Yes	Yes
Impedance	Z	Yes	Yes	Yes
Impedance Phase Angle	ANGL	Yes	Yes	Yes
Leakage Inductance	LL	Yes	Yes	Yes
Inter-winding Capacitance	C	Yes	Yes	Yes
Inter-winding Capacitance Match	C2	Yes	Yes	Yes
Turns Ratio and Phasing by Voltage	TR	No	Yes	Yes
Turns Ratio and Phasing by Inductance	TRL	Yes	Yes	Yes
Low open Circuit Voltage	LVOC	Yes	Yes	Yes
Inter-winding Phase	PHAS	Yes	Yes	Yes
Insertion Loss	ILOS	Yes	Yes	Yes
Return Loss	RLOS	Yes	Yes	Yes
Longitude Balance	LBAL	Yes	Yes	Yes
General Longitude Balance	GBAL	Yes	Yes	Yes
Frequency Response	RESP	Yes	Yes	Yes
Magnetizing Current	MAGI	No	Yes	Yes
Open Circuit Voltage	VOC	No	Yes	Yes
Wattage	WATT	No	Yes	Yes
Stress Wattage	STRW	No	Yes	Yes
Magnetizing Current (AC Interface)	MAGX	No	No	Yes
Open Circuit Voltage (AC Interface)	VOCX	No	No	Yes
Wattage (AC Interface)	WATX	No	No	Yes
Stress Wattage (AC Interface)	STRX	No	No	Yes
Leakage Current	ILK	No	Yes	Yes
Insulation Resistance	IR	No	Yes	Yes
Hi-Pot (DC)	HPDC	No	Yes	Yes
Hi-Pot (AC)	HPAC	No	Yes	Yes
Surge Stress	SURG	No	No	Yes
Output to User Port	OUT	N/a	N/a	N/a

13.5.2. Equipment Required

Short Circuit Compensation

A shorting bobbin is a required for short circuit compensation.

The aim here is to place a short across every winding defined in your test program.

This is normally a transformer bobbin with each winding replaced with a short circuit. To make a shorting bobbin, solder short pieces of wire across the relevant pins of either a) a blank bobbin or b) a completed transformer.

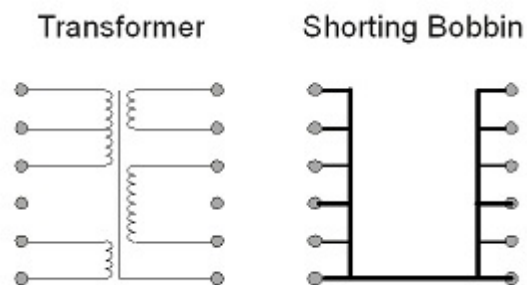

For simplicity, and flexibility you can short all pins, even if some are not used. This will give you a S/C bobbin that can be used for ANY transformer based on the same bobbin.

Open Circuit Compensation

For Open Circuit compensation, an empty bobbin should be used.

The aim here is to connect each Source and Measure pair on each of the 20 nodes that are used in your test program.

This allows the unit to measure the parasitic effect of the fixture and leads up to the point of contact with the transformer. This also allows any contact resistance in the connection of the pins/leads to transformer to be removed from your measurements.

If using a fixture with Kelvin blades, this ensures that source and measure sides of each blade pair are connected.

Load Compensation

A 'Standard Reference Component' is measured by a calibrated instrument. The value measured, Nominal Value, is then entered into the test program in the Load Compensation box. The results returned by the AT are then adjusted to compensate any stray parasitic from the system.

i.e., Standard Reference Component.

1. Nominal Value: Obtain the standard reference component pre-measured known value. The measured value = 100nH (Enter this value into the Test Program for Load Compensation)
2. When the AT5600 performs a Load Compensation, it measures say 120 nH. The ratio of Nominal Value / AT Measured Results is stored in the AT5600's memory as the Load Compensation Ratio. Example, this case 100nH / 120 nH = 0.833.
3. Then, when the program is run,

The Displayed Result = Load Compensation Ratio * measured value

In our case, $100\text{nH} = 0.833 * 120\text{ nH}$

After you have selected short circuit, open circuit, or load compensation and pressed the Run Button on the front panel, the tester will automatically perform all the compensation measurements and retain the results in internal memory.

The compensation factors will then be applied to each transformer as it is tested.

13.6. General Notes

The following general notes should be considered when constructing or modifying fixtures.

13.6.1. Beware of High Voltages

The AT5600 can apply DC voltages up to 7000 V DC and AC voltages up to 5000 V AC during a test. This must be kept in mind when constructing test fixtures.

If possible, always design the fixture with the nodes that experience the same high voltages grouped together.

An example of this is the common situation of performing Hi-pot tests between the primary windings as a group, and the secondary windings as a group.

The best layout for the test pins in this case (assuming this is not prohibited for other reasons) is to have all the primary windings connected to test nodes on one side of the fixture board (say the left-hand side using nodes 1, 3, 5, 7, etc.), and to have all the secondary windings connected to test nodes on the opposite side (for example, nodes 2, 4 and 6).

If, in addition, you need to test the isolation between two secondary windings, use the low-numbered nodes (say 2, 4 and 6) for one winding and a well separated group of high-numbered nodes (say 14, 16 and 18) for the other.

For PCB mounting transformers, clearly the spacing between the pins is determined by the transformer itself. If necessary, place pieces of high-voltage insulation between each Kelvin blade and its nearest neighbours, to prevent any high voltage flashover.

When separate terminals are used for transformers with flying leads, you should ensure that there is a generous separation between individual terminals to allow for the high voltages in your program. Consider both the exposed (high voltage) metal parts of the terminal itself, and the free ends of the transformer lead, which may be carelessly inserted and may bend around to touch an adjacent terminal. Ensure that there is a separation of at least 3 mm per kV between any sharp points in an air gap, assuming that the air is dry. Increase the separation still further for conditions of high humidity.

All leads between the terminals, or crocodile clips, and the contact pins on the AT5600 fixture plate should be covered with insulation capable of withstanding the test voltages you are using in your programs. They should be kept as short as possible, and the leads from one power-sense pair should not touch any bare metal associated with another power-sense pair.

Terminals or interconnections, which have exposed (high voltage) metal in contact with the surface of the fixture board, should be avoided where possible, as there may be creepage along the surface. If such a terminal is necessary, you must ensure that there are no sharp points or corners on the metal pieces, that

the surface between them is scrupulously clean, and that a separation of at least 3 mm per kV is used.

13.6.2. Kelvin Connections

Always use Kelvin connections (see section 13.4). In addition, when measuring extremely low transformer impedances, make sure that the Kelvin connections are continued through the terminal to the transformer leads.

13.6.3. Mechanical Problems

Always use terminals, sockets or probes that are mechanically robust. Poor mechanical connections can affect the measurements, and hence your throughput and quality of product.

In use, clean the fixtures and connectors regularly, to avoid any build-up of dirt and transformer varnish. Dirty fixtures give poor contacts and poor insulation resistance between contacts and could reduce the quality of your product.

Use a separate fixture for each type of wound component, as this can improve the testing throughput.

Design the fixture so that the connections to the component under test can be made quickly and easily. One example is to use guides to ensure that the component cannot be put on to the fixture the wrong way around.

It is most important that when removing insulation from single core wire that the conductor does not get marked or damaged when stripping as this will fracture in time when in use.

13.6.4. Cleaning Test Pins

The test pins on the bottom of the test fixture can also tarnish with age and accrue dirt and grease from the manufacturing environment.

Voltech recommends Chemtronics Pow-R-Wash VZ for cleaning the test pins/
<https://www.chemtronics.com/pow-r-wash-vz>

14. AT Series Editor Software

Create test programs for the AT Series Transformer Testers

The AT Editor user manual has now been removed from this manual and published as a separate standalone document.

The basic instruction on Firmware updates, Self-test and customising the AT5600 using the Editor have been left in this section, but also are in the main AT Editor manual too.

For the new dotNET AT Editor (V4.xx) please see
98-125 - AT Editor dot NET user manual

For the legacy AT Editor (v3.xx) please see
98-091 - AT Editor Legacy manual

Both are free to download from
www.voltech.com/support/downloads/

14.1. Firmware Upgrades

The firmware of the AT5600 controls how tests are carried out, which tests are available and how the interfaces (including the front panel) function. New versions of the firmware are made available periodically and electronic copies are available free of charge. To maximize the performance and longevity of your AT5600, you should install these upgrades as they become available.

See the Voltech website at <http://www.voltech.com/Support/Downloads> Upgrade firmware is distributed in a file called 'at5600-firmware-1-xxx-xxx.atfw'.

Firmware upgrades should ONLY be done over DIRECT USB to the AT5600 USB-B port., NOT via RS232 AUX PORT using an USB to RS232 adapter. Please also disconnect any AT5600 - ETHERNET connection if you use this for the AT SERVER

To upgrade the firmware.

a) Run the AT EDITOR software;
IMPORTANT; make sure you have latest version of AT Editor installed.

b) Connect AT EDITOR to AT5600 using USB from PC to the AT5600 USB-B port.
If you have not already done so you will need to install the free AT5600 USB drivers for the AT5600 The At5600 will then show up in Windows Device Manager under COM ports.

Select this valid COM port in Settings>communication.

c) On the Editor, select **Tester >Download Firmware.**

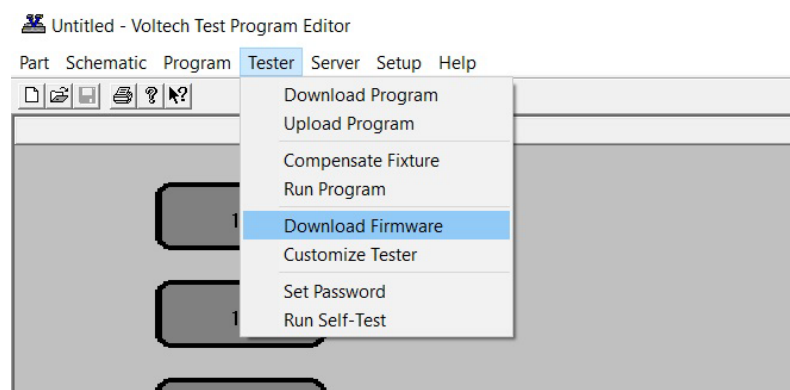

d) Locate the '11-184 ATFirmware.atfw' file you have downloaded (unzip it, first) and select it.

The firmware upgrade will now commence, and the editor screen will show a series of dialogue boxes to identify each stage in the process.

The download should take approximately 20 minutes.
During the process, the unit will reboot and may appear blank; **This is normal.**

In the unlikely event that the editor display shows an 'ERROR' or 'FAIL' dialogue box, before the download is complete (the AT5600 screen may also appear all white or blue or red), then try repeating the entire procedure from step (c)

Should the error persist then contact Voltech.

At the end of the download, the tester will reset itself and display the new Firmware version on the front panel.

You may then carry on using your tester as normal, with the benefits offered by the new firmware being available immediately.

WARNING: You must NOT switch off the AT or interrupt the communications during firmware updates. If this happens the download can be restarted and should always be successful.

the unit has boot code that never changes, so firmware upload can always be performed, even in the event of a previous download failure.

14.2. Self-Test

The self-test is a sequence of checks made by the tester to ensure the unit is functioning correctly. It cannot check that measurements will be made to specification, but it can check that most functionality is working correctly.

Although the AT5600 will automatically detect and report most faults that may cause incorrect measurements, it is recommended to run a system test at the start of each day for added confidence that the AT5600 is operating correctly.

The self-test can also be run via the Front Panel menu system, see section 8.1.7 Self-Test.



Before commencing system test, please ensure that there is no fixture fitted and nothing is touching any of the test nodes on the top surface of the AT5600. The self-test shall only run if the Safety Interlock is in the safe condition.

CAUTION: If the connections have been correctly made to the Safety Interlock, safe condition, then high voltage, generating up to 7000V, shall be present on all the test nodes on the top surface of the AT5600.

To run the Self-Test;

- a) Run the AT EDITOR software
- b) Connect AT EDITOR using USB (preferred) or RS232 comms to the AT5600.
- c) On the Editor, select **Tester >Run Self-Test**.

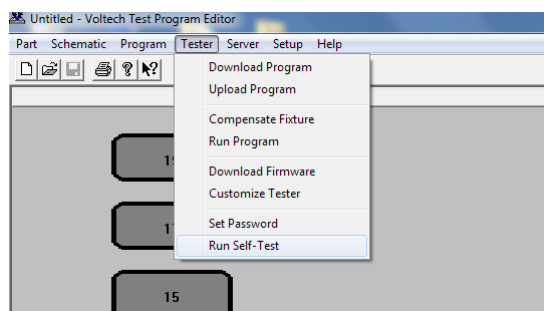

- d) At the 'Save As' prompt, assign a name for the file which the results will be saved to, in the example below, the file name is SelfTest.xml, then click Save.

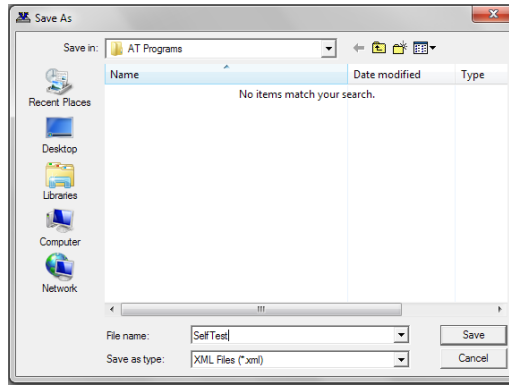

e) The self-test shall start, and the following prompt shall appear on the screen.

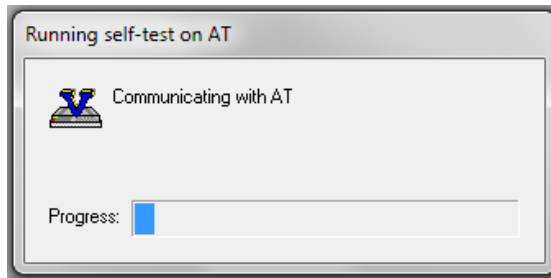

f) A prompt shall be displayed when the Self-Test is complete, as shown below.

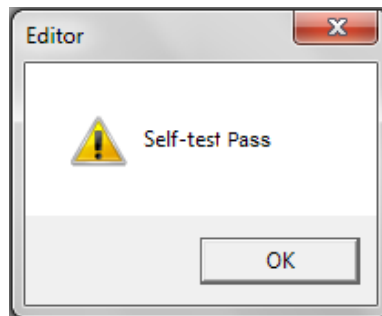

g) If the self-test detects a failure, a Self-Test Fail shall pop-up, contact your Voltech supplier for service. Please include the self-test log file, SelfTest.xml, with your inquiry for service.

14.3. Customize Tester

The Customize Tester feature in the AT Editor software shall be used to unlock newly purchased tests.

To determine which test are available, and which are enabled, please use the touch screen to navigate to
SET UP > UNIT INFORMATION > TEST LIST

Any locked test can be purchased or enabled for a 30-day trial by key code. Some tests in the list are in current development so may not be yet available.

To upgrade the AT5600 with new tests.

- a) Run the AT EDITOR software
- b) Connect AT EDITOR using USB (preferred) or RS232 comms to the AT5600.
- c) On the Editor, select **Tester >Send Key Code**.

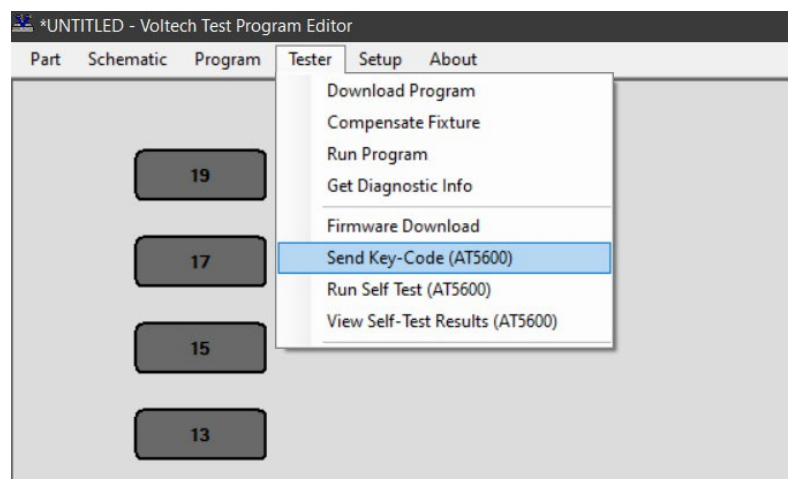

- d) The following pop-up window shall appear.

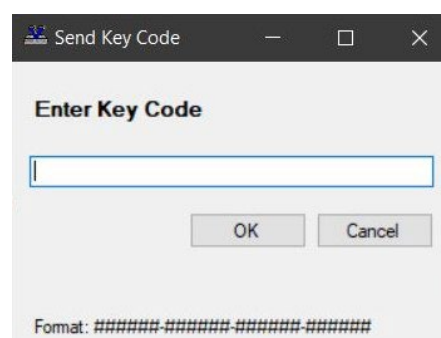

- e) Enter the new Key-code and then click Activate Key-code.
- f) Upon completion, a confirmation pop up will appear.

15. AT Series Server Software

Centralized data for the AT Series Transformer Testers

The AT Server user manual has now been removed from this manual and published as a separate standalone document.

For the new dotNET AT Server (V4.xx) please see
98-122 - AT Server dotNET user manual

For the legacy AT Server (V3.xx) please see
98-092 - AT Server Legacy manual

Both are free to download from
www.voltech.com/support/downloads/

16. Manual, Firmware, Software - Change Log

Please find below change history for this user manual, the AT5600 firmware and AT Series software.

All four of these items are free to download from our website, free of charge, for all users.

Voltech Instruments are committed to a policy of continuous product improvement and development.

Hence, product specification and the information given in this manual are subject to change.

The below will give an overview of improvements, new features, and corrections.

16.1. AT5600 User Manual

Version 25

9.1.4 added section on commonly seen status error codes.
Update some images to match newer AT5600 GUI.

Version 24

10.1.2 MAGI WATT VOC STRW now back to 40 Watts Maximum to match AT3600.
Editor dot NET has also been changed to allow higher limits to be programmed.
This increase does not require any hardware modification. FW 1.004.012

Version 23

10.3.3 foot switch no longer supplied- published components so users can easily build themselves.
5.6 / 8.1.6.2+3+5 Clarified that USB HID input characters can only be the same as the soft keyboard characters – A-Z, 0-9 , “-“ and “ “

Version 22

7.x – updated referenced to new dot net editor manual for programming tests. This is now a separate document 98-125.
7.x 10.x – ACRT DCRT ACVB DCVB tests have been withdrawn for use.
2.9 added clarity that both Editor and Server can be on same PC.
10.3.3 added recommended solid state COTO relay for use with remote port

Version 21

8.1.15 updated for new USB A 1+2 icons on front panel for Keyboard, Barcode or Printer identification.
14 + 15 updated to point to new standalone user manuals for AT editor and AT server software.

Version 20

Added instructions for AT3600 compatibility mode and new Language settings.
Compatibility mode will only be available when used with the updated version of dotNET AT Server that will be released in future.

Version 19

8.1.13 added instructions for NEW AT3600 compatibility mode and NEW Language settings
7.48 - added WAIT test for future release
7.49 + 10.2.33 - added PWRP power factor test for future release
7.25 PHAS - Convention for returned result added and clarified.

Version 18

Maintenance release to match FW 1.002.039

Version 17

7.37 7.38 7.39 referred to 7.13 for best practice when testing autotransformers + centre taps to avoid common mode errors with Hi LO nodes.
7.7 added clarity on LS LP models used.
4.1.4 added clarity on LPG max current.
7.13 / 7.14 updated to refer to LS table for best test conditions as with any of the other LPG test.
1.4 updated package contents.
General index updates to allow named destinations for simpler direct web links to pages

Version 16

14.5.1 + 14.5.3 Audit and diagnostic test now return “0.000” on a run where they are not invoked.

Version 15

9.2.3 Updated definition of VPRES after HPAC HPDC IR test to make clearer the (silent) operation of this feature, and criteria for triggering of this VPRES error code.
7.27+28+29, 14.6.23+24+25 Added "best practice advice" on using all available nodes for HPAC, HPDC and IR to ensure controlled ramp down and discharge on all of the transformer.
7.14+ 14.6.11 TRL – defined the functionality if AUTO conditions are selected for the secondary on the TRL test.
5.6 + 8.1.6.2/3/4/6 + 8.11.4 Added USB Barcode reader functionality , set up, use and status icons
8.1.13 Added new screen to display available tests, and test status of demo tests.
8.1.6.8 Added new Schematic Screen.
8.1.6.5 + 13.5 Added details on new Automatic Compensation Storage feature implemented in this release.

Version 14

10.xx Added AR terms to each spec page for ease of use.
15.5.5.3 Added tips to database section regarding POL tests
14.5.2.3 Add hints and tips on best test grouping for optimum speed execution.

Version 13

10.1 Corrected typo in LVOC measurement spec – corrected from 100mV minimum to 1mv minimum.
14.5.10 Removed Password protection from AT SERVER as this is a very outdated way of protecting programs. Read/Write permissions on folders via your IT system is the simplest and preferred way to secure ATP files.

Version 12

14.5.1.12 + 14.5.3 Added clear definition of "-1e-15" results for Audit and Diagnostic tests, when not executed.
14.5.1.15 Custom text now available.
10.3.6 Added definition of switching times to OUT TEST.
14.5.1.9 Clarification of Date and Time on Results setting in AT Editor.

Version 11

7.30 Updated SURGE description with explanation of variable sample rates and limits
7.32 +34+36+38 Added explanation for X-tests and voltage trimming when using a step-up transformer and AC Interface
10.1 Corrected typo in lower measurement range on HPAC HPDC etc. – should be uA, not mA
7.37 Added note about using VOC with constant current settings.
8.xxx Updated all of chapter 8 for the new GUI on V1.000.000 of the firmware.
10.3.3 Added details of Voltech Foot switch to REMOTE port section.
15.5.5.3 Added explanation for IDs used in the 4 server database tables.
10.2.7 removed ambiguity in MAGX specification for ease of calculation.
10.2.19 Simplified GBAL spec to be same as LBAL
10.2.25 Corrected typo in PHAS Ac specification term.

16.2. AT5600 Firmware

Release notes are now only published on line here

<https://www.voltech.com/support/at5600-support-home/at5600-firmware-release-notes/>

Voltech AT5600 Transformer Tester

AT5600 User Manual

© Voltech Instruments All rights reserved.

No part of this publication may be produced, stored in a retrieval system, or transmitted in any form, or by means, electronic, mechanical photocopying, recording or otherwise without prior written permission of Voltech.